

NPort 5200 Series User's Manual

Ninth Edition, September 2014

www.moxa.com/product

MOXA®

© 2013 Moxa Inc. All rights reserved.

NPort 5200 Series User's Manual

The software described in this manual is furnished under a license agreement and may be used only in accordance with the terms of that agreement.

Copyright Notice

© 2013 Moxa Inc. All rights reserved.

Trademarks

The MOXA logo is a registered trademark of Moxa Inc.
All other trademarks or registered marks in this manual belong to their respective manufacturers.

Disclaimer

Information in this document is subject to change without notice and does not represent a commitment on the part of Moxa.

Moxa provides this document as is, without warranty of any kind, either expressed or implied, including, but not limited to, its particular purpose. Moxa reserves the right to make improvements and/or changes to this manual, or to the products and/or the programs described in this manual, at any time.

Information provided in this manual is intended to be accurate and reliable. However, Moxa assumes no responsibility for its use, or for any infringements on the rights of third parties that may result from its use.

This product might include unintentional technical or typographical errors. Changes are periodically made to the information herein to correct such errors, and these changes are incorporated into new editions of the publication.

Technical Support Contact Information

www.moxa.com/support

Moxa Americas

Toll-free: 1-888-669-2872
Tel: +1-714-528-6777
Fax: +1-714-528-6778

Moxa Europe

Tel: +49-89-3 70 03 99-0
Fax: +49-89-3 70 03 99-99

Moxa China (Shanghai office)

Toll-free: 800-820-5036
Tel: +86-21-5258-9955
Fax: +86-21-5258-5505

Moxa Asia-Pacific

Tel: +886-2-8919-1230
Fax: +886-2-8919-1231

Table of Contents

1. Introduction	1-1
Overview	1-2
Package Checklist	1-2
Product Features	1-2
Product Specifications	1-3
2. Getting Started	2-1
Panel Layout	2-2
Connecting the Hardware	2-3
Wiring Requirements	2-3
Connecting the Power	2-3
Grounding the NPort 5200	2-3
Connecting to the Network	2-4
Connecting to a Serial Device	2-4
LED Indicators	2-4
3. Initial IP Address Configuration	3-1
Initializing the NPort 5200's IP Address	3-2
Factory Default IP Address	3-2
NPort Administration Suite	3-2
ARP	3-2
Telnet Console	3-3
Serial Console (19200, n, 8, 1)	3-6
4. Choosing the Proper Operation Mode	4-1
Overview	4-2
Real COM Mode	4-2
TCP Server Mode	4-3
TCP Client Mode	4-3
UDP Mode	4-4
Pair Connection Mode	4-4
Reverse Telnet Mode	4-4
Disabled Mode	4-5
5. Web Console Configuration	5-1
Opening Your Browser	5-2
Basic Settings	5-4
Time	5-4
Web/Telnet Console	5-5
Network Settings	5-6
SNMP Settings	5-8
IP Address Report	5-8
Serial Settings	5-9
Serial Parameters	5-9
Operating Settings	5-10
Real COM Mode	5-11
TCP Server Mode	5-13
TCP Client Mode	5-16
UDP Mode	5-20
Pair Connection Mode	5-22
Pair Connection Master Mode	5-22
Pair Connection Slave Mode	5-23
Reverse Telnet Mode	5-23
Disabled Mode	5-24
Accessible IP Settings	5-25
Auto Warning Settings	5-26
Auto warning: Email and SNMP trap	5-26
Mail Server	5-26
SNMP Trap Server	5-27
Event Type	5-27
DCD changed	5-27
DSR changed	5-28
Monitor	5-28
Monitor Line	5-28
Monitor Async	5-29
Monitor Async-Settings	5-29
Change Password	5-29
Load Factory Default	5-30
6. Configuring NPort Administrator	6-1
Overview	6-2

Installing NPort Administrator	6-2
Configuration	6-4
Broadcast Search	6-5
Unlock Password Protection	6-6
Configuring the NPort 5200	6-7
Upgrading the Firmware	6-9
Export Configuration	6-10
Import Configuration	6-11
Monitor	6-11
Port Monitor	6-17
COM Mapping	6-17
On-line COM Mapping	6-18
Off-line COM Mapping	6-22
IP Address Report	6-23
7. NPort CE Driver Manager for Windows CE	7-1
Overview	7-2
Installing NPort CE Driver Manager	7-2
Using NPort CE Driver Manager	7-2
8. IP Serial LIB	8-1
Overview	8-2
IP Serial LIB Function Groups	8-2
Example Program	8-3
A. Pinouts and Cable Wiring	A-1
Port Pinout Diagrams	A-2
Ethernet Port Pinouts	A-2
Serial Port Pinouts	A-2
Cable Wiring Diagrams	A-3
Ethernet Cables	A-3
Serial Cables	A-3
B. Well Known Port Numbers	B-1
C. SNMP Agents with MIB II & RS-232 like Groups	C-1
D. Auto IP Report Protocol	D-1
E. Compliance Notice	E-1

Introduction

The NPort 5200 Series of advanced serial device servers make it easy to network enable your serial devices. The NPort 5200 Series includes 4 models: NPort 5210/5210-T (2 ports for RS-232), NPort 5230/5230-T (1 port for RS-232; 1 port for RS-422/485), NPort 5232/5232-T (2 ports for RS-422/485), and NPort 5232I/5232I-T (2 ports for RS-422/485, with isolation protection). In this manual, we refer to the four products collectively as “NPort 5200” or “NPort 5200 Series.”

The following topics are covered in this chapter:

- ❑ **Overview**
- ❑ **Package Checklist**
- ❑ **Product Features**
- ❑ **Product Specifications**

Overview

The NPort 5200 Series serial device servers are designed to make your industrial serial devices Internet ready in no time. The compact size of NPort 5200 device servers makes them the ideal choice for connecting your RS-232 (NPort 5210/5230/5210-T/5230-T) or RS-422/485 (NPort 5230/5232/ 5232I/5230-T/5232-T/5232I-T) serial devices—such as PLCs, meters, and sensors—to an IP-based Ethernet LAN, making it possible for your software to access serial devices from anywhere over a local LAN or the Internet.

The NPort 5200 serial device servers ensure the compatibility of network software that uses a standard network API (Winsock or BSD Sockets) by providing TCP Server Mode, TCP Client Mode, and UDP Mode. And thanks to the NPort 5200 Series' Real COM/TTY drivers, software that works with COM/TTY ports can be set up to work over a TCP/IP network, without modifying your serial COM software applications. This excellent feature preserves your software investment and lets you enjoy the benefits of networking your serial devices instantly.

The NPort 5200 serial device servers support automatic IP configuration protocols (DHCP, BOOTP) and manual configuration via the handy web browser console. Both methods ensure quick and effective installation. And with the NPort 5200's Windows Utility, installation is very straightforward, since all system parameters can be stored and then copied to other device servers simultaneously.

Package Checklist

The NPort 5200 Series products are shipped with the following items:

Standard Accessories

- 1 NPort 5200 2-port serial device server
- Document & Software CD
- NPort 5200 Series Quick Installation Guide

Optional Accessories

- DK-35A DIN-Rail Mounting Kit (35 mm)
- CBL-RJ45M9-150 RJ45 (8-pin) to DB9 (M) cable, 150 cm
- CBL-RJ45F9-150 RJ45 (8-pin) to DB9 (F) cable, 150 cm
- CBL-RJ45M25-150 RJ45 (8-pin) to DB25 (M) cable, 150 cm
- CBL-RJ45F25-150 RJ45 (8-pin) to DB25 (F) cable, 150 cm

NOTE: Notify your sales representative if any of the above items is missing or damaged.

Product Features

The NPort 5200 Series device servers have the following features:

- Make your serial devices Internet ready instantly
- Versatile socket operation modes, including TCP Server, TCP Client, and UDP
- Easy-to-use Windows Utility for installing multiple device servers
- Cigarette pack size
- Auto detectable 10/100 Mbps Ethernet port
- 2- or 4-wire RS-485 (NPort 5230/5232/5232I/5230-T/5232-T/5232I-T) with patented ADDC™ (Automatic Data Direction Control)
- SNMP MIB-II supported for network management
- Pair Connection mode for connecting two serial devices over a network without a PC
- Reverse Telnet

Product Specifications

Ethernet Interface

Number of Ports: 1

Speed: 10/100 Mbps, auto MDI/MDIX

Connector: 8-pin RJ45

Magnetic Isolation Protection: 1.5 kV built-in

Serial Interface

Number of Ports: 2

Serial Standards:

NPort 5210: RS-232

NPort 5230: 1 RS-232 port, 1 RS-422/485 port

NPort 5232/5232I: RS-422/485

Connector:

NPort 5210: RJ45 (8 pins)

NPort 5230/5232/5232I: Terminal Block (5 contacts per port)

Serial Line Protection: 2 kV isolation protection (NPort 5232I/5232I-T)

RS-485 Data Direction Control: ADDC® (automatic data direction control)

Serial Communication Parameters

Data Bits: 5, 6, 7, 8

Stop Bits: 1, 1.5, 2

Parity: None, Even, Odd, Space, Mark

Flow Control: RTS/CTS (RS-232 only), DTR/DSR (NPort 5210 only), XON/XOFF

Baudrate: 110 bps to 230.4 kbps

Serial Signals

RS-232:

NPort 5210: TxD, RxD, RTS, CTS, DTR, DSR, DCD, GND

NPort 5230: TxD, RxD, RTS, CTS, GND

RS-422: Tx+, Tx-, Rx+, Rx-, GND

RS-485-4w: Tx+, Tx-, Rx+, Rx-, GND

RS-485-2w: Data+, Data-, GND

Software

Network Protocols: ICMP, IPv4, TCP, UDP, DHCP, BOOTP, Telnet, DNS, SNMP V1, HTTP, SMTP, SNMP

Configuration Options: Web Console, Serial Console (NPort 5210/5230 only), Telnet Console, Windows Utility

Windows Real COM Drivers: Windows 95/98/ME/NT/2000, Windows XP/2003/Vista/2008/7/8/8.1

(x86/x64), Windows 2008 R2/2012/2012 R2 (x64), Windows Embedded CE 5.0/6.0, Windows XP Embedded

Fixed TTY Drivers: SCO Unix, SCO OpenServer, UnixWare 7, QNX 4.25, QNX 6, Solaris 10, FreeBSD, AIX 5.x, HP-UX 11i, Mac OS X

Linux Real TTY Drivers: Linux 2.4.x, 2.6.x, 3.x

Physical Characteristics

Housing: Metal

Weight:

NPort 5210: 340 g

NPort 5230/5232: 360 g

NPort 5232I: 380 g

Dimensions:

NPort 5210/5230/5232:

Without ears: 67 x 100.4 x 22 mm (2.64 x 3.95 x 0.87 in)

With ears: 90 x 100.4 x 22 mm (3.54 x 3.95 x 0.87 in)

NPort 5232I:

Without ears: 67 x 100.4 x 35 mm (2.64 x 3.95 x 1.37 in)

With ears: 90 x 100.4 x 35 mm (3.54 x 3.95 x 1.37 in)

Environmental Limits

Operating Temperature:

Standard Models: 0 to 55°C (32 to 131°F)

Wide Temp. Models: -40 to 75°C (-40 to 167°F)

Storage Temperature: -40 to 75°C (-40 to 167°F)**Ambient Relative Humidity:** 5 to 95% (non-condensing)**Altitude:** Up to 2000 m

Note: Please contact Moxa if you require products guaranteed to function properly at higher altitudes.

Power Requirements

Input Voltage: 12 to 48 VDC**Power Consumption:**

NPort 5210: 325 mA @ 12 V, 190 mA @ 24 V

NPort 5230: 325 mA @ 12 V, 190 mA @ 24 V

NPort 5232: 280 mA @ 12 V, 150 mA @ 24 V

NPort 5232I: 365 mA @ 12 V, 200 mA @ 24 V

Standards and Certifications

EMI: EN55022 Class A, FCC part 15 Subpart B Class A**EMS:**

EN 61000-4-2 ESD: contact 4 kV; air 8 kV

EN 61000-4-3 RS: 3 V/m (80 MHz to 1 GHz)

EN 61000-4-4 EFT: Power 1 kV; Signal 0.5 kV

EN 61000-4-5 Surge: AC 1 kV

EN 61000-4-6 CS: 3 V

EN 61000-4-8

EN 61000-4-11

Safety: UL 60950-1, EN 60950-1**EMC:** 55022/24**Marine:** DNV**Medical:** (NPort 5210 only) EN 60601-1-2 Class B, EN55011

Reliability

Alert Tools: Built-in buzzer and RTC (real-time clock)**Automatic Reboot Trigger:** Built-in WDT (watchdog timer)**MTBF (mean time between failures):**

NPort 5210: 134,850 hrs

NPort 5230: 106,955 hrs

NPort 5232: 102,344 hrs

NPort 5232I: 87,083 hrs

Warranty

Warranty Period: 5 years**Details:** See www.moxa.com/warranty

2

Getting Started

In this chapter, we give instructions on how to install the NPort 5200 device servers. Software installation is covered in subsequent chapters.

The following topics are covered in this chapter:

▣ **Panel Layout**

▣ **Connecting the Hardware**

- Wiring Requirements
- Connecting the Power
- Grounding the NPort 5200
- Connecting to the Network
- Connecting to a Serial Device
- LED Indicators

Panel Layout

NPort 5210/5210-T

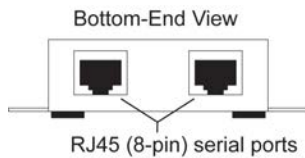
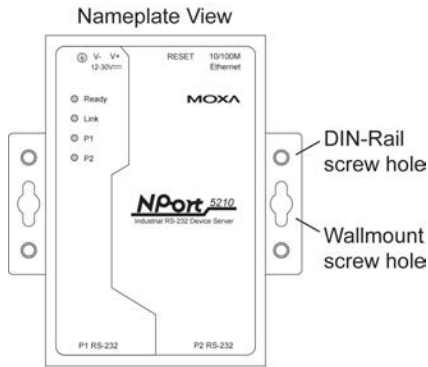
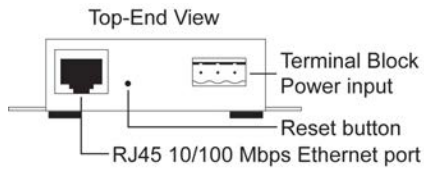

NPort 5230/5230-T

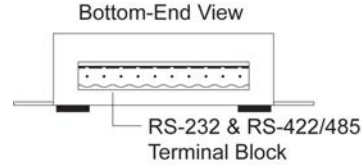
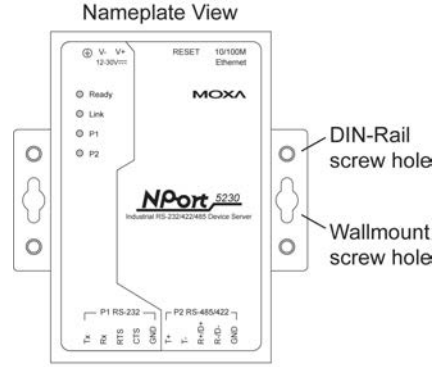
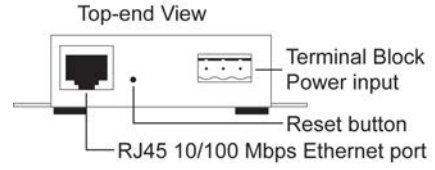

NPort 5232/5232-T

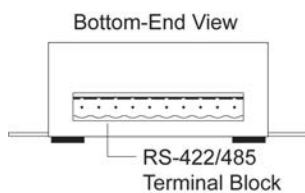
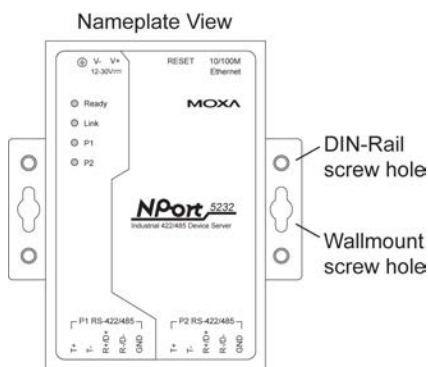
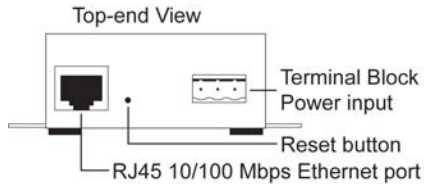

NPort 52321/52321-T

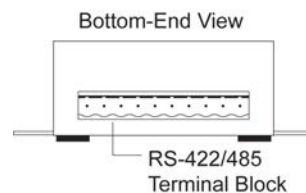
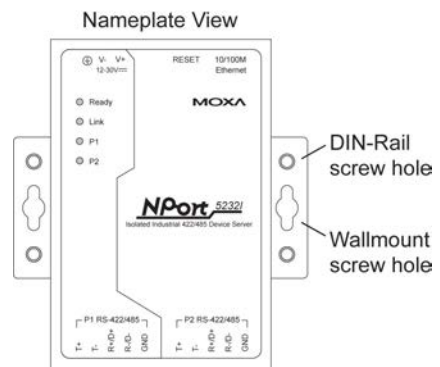
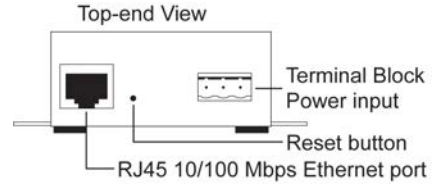

Connecting the Hardware

This section describes how to connect the NPort 5200 to serial devices for first time testing purposes. We cover **Wiring Requirements**, **Connecting the Power**, **Grounding the NPort 5200**, **Connecting to the Network**, **Connecting to a Serial Device**, and **LED Indicators**.

Wiring Requirements



ATTENTION

Safety First!

Be sure to disconnect the power cord before installing and/or wiring your NPort 5200.

Wiring Caution!

Calculate the maximum possible current in each power wire and common wire. Observe all electrical codes dictating the maximum current allowable for each wire size.

If the current goes above the maximum ratings, the wiring could overheat, causing serious damage to your equipment.

Temperature Caution!

Please take care when handling the NPort 5200. When plugged in, the NPort 5200's internal components generate heat, and consequently the casing may feel hot to the touch.

You should also heed the following:

- Use separate paths to route wiring for power and devices. If power wiring and device wiring paths must cross, make sure the wires are perpendicular at the intersection point.

NOTE: Do not run signal or communication wiring and power wiring in the same wire conduit. To avoid interference, wires with different signal characteristics should be routed separately.

- You can use the type of signal transmitted through a wire to determine which wires should be kept separate. The rule of thumb is that wiring that shares similar electrical characteristics can be bundled together.
- Keep input wiring and output wiring separate.
- Where necessary, it is strongly advised that you label wiring to all devices in the system.

Connecting the Power

Connect the 12-48 VDC power line with the NPort 5200's terminal block. If the power is properly supplied, the "Ready" LED will show a solid red color until the system is ready, at which time the "Ready" LED will change to a green color.

Grounding the NPort 5200

Grounding and wire routing helps limit the effects of noise due to electromagnetic interference (EMI). Run the ground connection from the ground screw to the grounding surface prior to connecting devices.



ATTENTION

This product is intended to be mounted to a well-grounded mounting surface such as a metal panel.

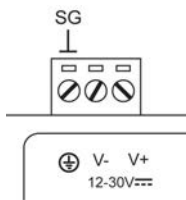

SG: The *Shielded Ground* (sometimes called *Protected Ground*) contact is the left most contact of the 3-pin power terminal block connector when viewed from the angle shown here. Connect the SG wire to an appropriate grounded metal surface.

Connecting to the Network

Connect one end of the Ethernet cable to the NPort 5200's 10/100M Ethernet port and the other end of the cable to the Ethernet network. If the cable is properly connected, the NPort 5200 will indicate a valid connection to the Ethernet in the following ways:

- The Ethernet LED maintains a solid green color when connected to a 100 Mbps Ethernet network.
- The Ethernet LED maintains a solid orange color when connected to a 10 Mbps Ethernet network.
- The Ethernet LED will flash when Ethernet packets are being transmitted or received.

Connecting to a Serial Device

Connect the serial data cable between the NPort 5200 and the serial device. Serial data cables are optional accessories for NPort 5210. Refer to Chapter 1 under **Optional Accessories** for information about the RJ45-to-DB25 and RJ45-to-DB9 cables.

LED Indicators

The top panels of all the NPort 5200 device servers have four LED indicators, as described in the following table.

LED Name	LED Color	LED Function
Ready	red	Steady on: Power is on and NPort 5200 is booting up. Blinking: Indicates an IP conflict, or DHCP or BOOTP server did not respond properly.
	green	Steady on: Power is on and NPort 5200 is functioning normally. Blinking: The device server has been located by Administrator's Location function.
	off	Power is off, or power error condition exists.
Ethernet	orange	10 Mbps Ethernet connection.
	green	100 Mbps Ethernet connection.
	off	Ethernet cable is disconnected, or has a short.
P1, P2	orange	Serial port is receiving data.
	green	Serial port is transmitting data.
	off	No data is being transmitted or received through the serial port.

Initial IP Address Configuration

When setting up your NPort 5200 for the first time, the first thing you should do is configure the IP address. This chapter introduces the methods that can be used to configure the device server's IP address. *Select one of the initial IP Address configuration methods to configure the NPort 5200's IP Address.* For more details about network settings, see the Network Settings section from Chapter 5, *Web Console Configuration*.

The following topics are covered in this chapter:

- ❑ **Initializing the NPort 5200's IP Address**
- ❑ **Factory Default IP Address**
- ❑ **NPort Administration Suite**
- ❑ **ARP**
- ❑ **Telnet Console**
- ❑ **Serial Console (19200, n, 8, 1)**

Initializing the NPort 5200's IP Address

1. Determine whether your NPort 5200 needs to use a Static IP or Dynamic IP (either DHCP or BOOTP application).
2. **If the NPort 5200 is used in a Static IP environment**, you can use NPort 5200 Administration Suite, Web Console, Telnet Console or Serial Console to configure the new IP address.
3. **If the NPort 5200 is used in a Dynamic IP environment**, you can use NPort 5200 Administration suite, Web Console, Telnet Console, or Serial Console to configure the NPort 5200 to get an IP address dynamically with DHCP, DHCP/BOOTP, or BOOTP.



ATTENTION

Consult your network administrator to learn how to reserve a fixed IP address for your NPort 5200 in the MAC-IP mapping table when using a DHCP Server or BOOTP Server. For most applications, you should assign a fixed IP address to your NPort 5200.

Factory Default IP Address

NPort 5200 device servers are configured with the following default private IP address:

Default IP address: 192.168.127.254

(IP addresses of the form 192.168.xxx.xxx are referred to as private IP addresses, since it is not possible to access a device configured with a private IP address directly from a public network. For example, you would not be able to ping such a device from an outside Internet connection. NPort 5200 applications that require sending data over a public network, such as the Internet, require setting up the server with a valid public IP address, which can be leased from a local ISP.)

NPort Administration Suite

NPort Administration Suite consists of useful utility programs that are used to configure and manage your NPort 5200 device server.

See Chapter 5 for details on how to install NPort Administration Suite, and how to use this suite of useful utilities to set up IP addresses and configure your NPort 5200 Series serial device servers.

ARP

You can use the ARP (Address Resolution Protocol) command to set up an IP address for your NPort 5200. The ARP command tells your computer to associate the NPort 5200's MAC address with the intended IP address. You must then use Telnet to access the NPort 5200, at which point the device server's IP address will be reconfigured.



ATTENTION

In order to use this setup method, both your computer and the NPort 5200 must be connected to the same LAN. Or, you may use a cross-over Ethernet cable to connect the NPort 5200 directly to your computer's Ethernet card. Your NPort 5200 must be configured with the factory default IP address—192.168.127.254—before executing the ARP command, as described below.

Take the following steps to use ARP to configure the IP address:

1. Obtain a valid IP address for your NPort 5200 from your network administrator.
2. Obtain the NPort 5200's MAC address from the label on its bottom panel.
3. Execute the 'arp -s' command from your computer's MS-DOS prompt by typing:

```
arp -s 192.168.200.100 00-90-E8-xx-xx-xx
```

This is where 192.168.200.100 is the new IP address and 00-90-E8-xx-xx-xx is the MAC address for your NPort 5200. (Be sure to use the actual IP address and MAC address for your NPort 5200.)

4. Next, execute a special Telnet command by typing:

```
telnet 192.168.200.100 6000
```

After issuing this command, a **Connect failed** message will appear, as shown here. After the NPort 5200 reboots, its IP address will be updated to the new address, and you can reconnect using either Telnet, Web, or Administrator to check that the update was successful.

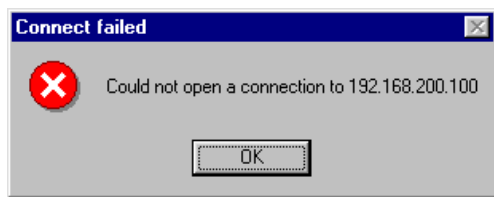

Telnet Console

Depending on how your computer and network are configured, you may find it convenient to use network access to set up your NPort 5200's IP address. This can be done using the Telnet.

1. From the Windows desktop, click on **Start** and then select **Run**.
2. Type telnet 192.168.127.254 (use the correct IP address if different from the default) in the **Open** text input box, and then click on **OK**.

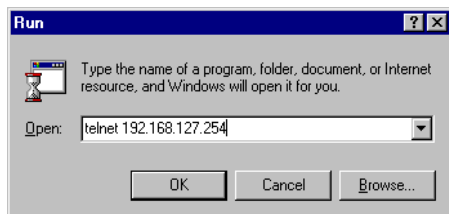

3. When the Telnet window opens, if you are prompted to input the **Console password**, input the password and then press **Enter**.

Note that this page will only appear if the NPort 5200 is password protected.

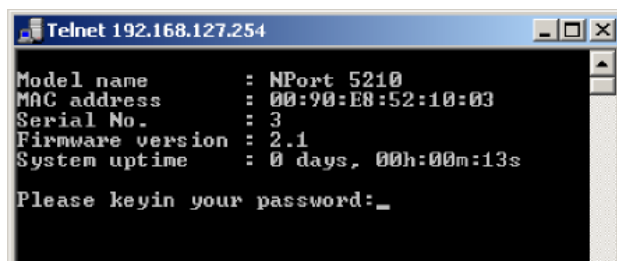

4. Type **2** to select **Network settings**, and then press **Enter**.

```

<< Main Menu >>
(1) Basic settings
(2) Network settings
(3) Serial settings
(4) Operating settings
(5) Accessible IP settings
(6) Auto warning settings
(7) Monitor
(8) Ping
(9) Change password
(a) Load factory default
(v) View settings
(s) Save/Restart
(q) Quit

Key in your selection: 2

```

5. Type **1** to select **IP address** and then press **Enter**.

```

<< Main Menu->Network settings >>
(1) IP address
(2) Netmask
(3) Gateway
(4) IP configuration
(5) DNS server 1
(6) DNS server 2
(7) SNMP
(8) SNMP community name
(9) SNMP contact
(a) SNMP location
(b) Auto IP report to IP
(c) Auto IP report to TCP port
(d) Auto IP report period
(v) View settings
(m) Back to main menu
(q) Quit

Key in your selection: 1_

```

6. Use the Backspace key to erase the current IP address, type in the new IP address, and then press Enter.

```

<< Main Menu->Network settings >>
(1) IP address
(2) Netmask
(3) Gateway
(4) IP configuration
(5) DNS server 1
(6) DNS server 2
(7) SNMP
(8) SNMP community name
(9) SNMP contact
(a) SNMP location
(b) Auto IP report to IP
(c) Auto IP report to TCP port
(d) Auto IP report period
(v) View settings
(m) Back to main menu
(q) Quit

Key in your selection: 1
IP address: 192.168.127.253_

```

7. Press any key to continue.

```
<< Main Menu->Network settings >>
(1) IP address
(2) Netmask
(3) Gateway
(4) IP configuration
(5) DNS server 1
(6) DNS server 2
(7) SNMP
(8) SNMP community name
(9) SNMP contact
(a) SNMP location
(b) Auto IP report to IP
(c) Auto IP report to TCP port
(d) Auto IP report period
(v) View settings
(m) Back to main menu
(q) Quit

Key in your selection: 1
IP address: 192.168.127.253
Set IP address success

Press any key to continue...
```

8. Type **m** and then press **Enter** to return to the main menu.

```
<< Main Menu->Network settings >>
(1) IP address
(2) Netmask
(3) Gateway
(4) IP configuration
(5) DNS server 1
(6) DNS server 2
(7) SNMP
(8) SNMP community name
(9) SNMP contact
(a) SNMP location
(b) Auto IP report to IP
(c) Auto IP report to TCP port
(d) Auto IP report period
(v) View settings
(m) Back to main menu
(q) Quit

Key in your selection: m
```

9. Type **s** and then press **Enter** to **Save/Restart** the system.

```

<< Main Menu >>
<1> Basic settings
<2> Network settings
<3> Serial settings
<4> Operating settings
<5> Accessible IP settings
<6> Auto warning settings
<7> Monitor
<8> Ping
<9> Change password
<a> Load factory default
<v> View settings
<s> Save/Restart
<q> Quit

Key in your selection: s_

```

10. Type **y** and then press **Enter** to save the new IP address and restart the NPort 5200.

```

Ready to restart
<y> Yes
<n> No

Key in your selection: y_

```

Serial Console (19200, n, 8, 1)

You may use the RS-232 console port to set up the IP address for NPort 5200. We suggest using PComm Terminal Emulator, which is available free of charge as part of the PComm Lite program suite (found on the Software CD that comes with the product), to carry out the installation procedure, although other similar utilities may also be used.



ATTENTION

The Serial Console can only be accessed by NPort 5200's RS-232 ports Port 1 for NPort 5210 and NPort 5230. Since NPort 5232 and NPort 5232I do not have an RS-232 interface, the Serial Console program cannot be used to configure NPort 5232/5232I's IP address.

Before you use the serial console to configure the NPort 5200, turn off the power and connect the serial cable from NPort 5200 to your computer's serial port.

1. Connect NPort 5200's serial port 1 directly to your computer's male RS-232 serial port.
2. From the Windows desktop, click on **Start** → **Programs** → **PComm Lite** → **Terminal Emulator**.
3. When the **PComm Terminal Emulator** window opens, first click on the **Port Manager** menu item and select **Open**, or simply click on the **Open** icon.

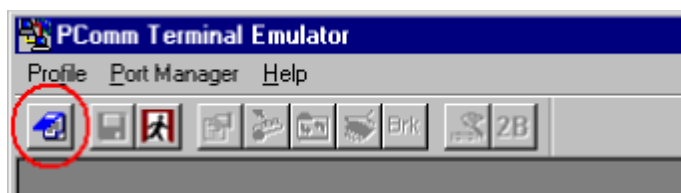

- The **Property** window opens automatically. From the **Communication Parameter** page, select the appropriate COM port for the connection, **COM1** in this example, and **19200** for **Baud Rate**, **8** for **Data Bits**, **None** for **Parity**, and **1** for **Stop Bits**.
- From the Property window's **Terminal** page, select **ANSI** or **VT100** for **Terminal Type** and then click **OK**. If you select **Dumb Terminal** as the terminal type, some of the console functions—especially the “Monitor” function—may not work properly.

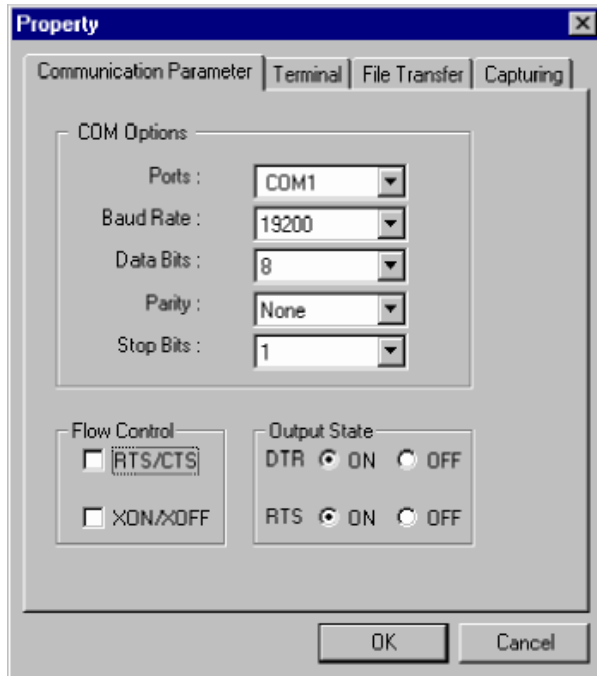

- Press the “ ` ” key continuously and then power on the NPort 5200.



- NPort 5200 will switch automatically from data mode to console mode as it receives a continuous “ ` ” string.
- Input the password when prompted. Note that this page will only appear when the NPort 5200 has been set up for password protection.

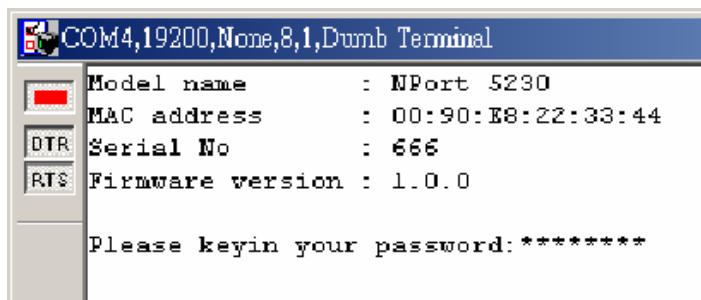

9. Start configuring the IP address under **Network Settings**. Refer to step 4 in the **Telnet Console** section for the rest of the IP settings.

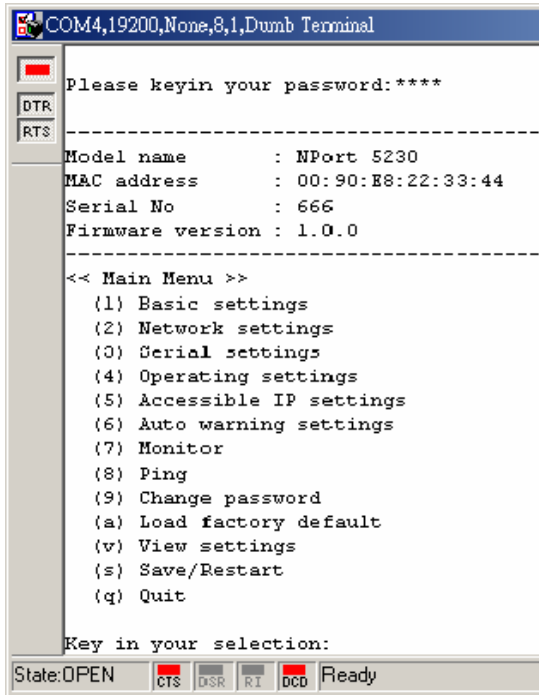

```
COM4,19200,None,8,1,Dumb Terminal
Please keyin your password:****
-----
Model name       : NPort 5230
MAC address      : 00:90:E8:22:33:44
Serial No        : 666
Firmware version : 1.0.0
-----
<< Main Menu >>
(1) Basic settings
(2) Network settings
(0) Serial settings
(4) Operating settings
(5) Accessible IP settings
(6) Auto warning settings
(7) Monitor
(8) Ping
(9) Change password
(a) Load factory default
(v) View settings
(s) Save/Restart
(q) Quit
Key in your selection:
State:OPEN  cts DSR RI dcd Ready
```

Choosing the Proper Operation Mode

In this chapter, we describe the various NPort 5200 operation modes. The options include “Driver Mode,” which uses a driver installed on the host computer, and operation modes that rely on TCP/IP socket programming concepts. After reading this chapter, choose the operation mode most suitable for your application, and then refer to Chapter 5 for detailed instructions on how to configure the operation mode’s parameters.

The following topics are covered in this chapter:

- ❑ **Overview**
- ❑ **Real COM Mode**
- ❑ **TCP Server Mode**
- ❑ **TCP Client Mode**
- ❑ **UDP Mode**
- ❑ **Pair Connection Mode**
- ❑ **Reverse Telnet Mode**
- ❑ **Disabled Mode**

Overview

NPort 5200 serial device servers network-enable traditional RS-232/422/485 devices. A serial device server is a tiny computer equipped with a CPU, real-time OS, and TCP/IP protocols that can bi-directionally transform data between the serial and Ethernet formats. By incorporating serial device servers in your application, you will be able to access, manage, and configure remote facilities and equipment over the Internet from anywhere in the world.

Traditional SCADA and data collection systems rely on serial ports (RS-232/422/485) to collect data from various kinds of instruments. Since NPort 5200 Serial Device Servers network-enable instruments equipped with an RS-232/422/485 communication port, your SCADA and data collection system will be able to access all instruments connected to a standard TCP/IP network, regardless of whether the devices are used locally or at a remote site.

The NPort 5200 is an external IP-based network device that allows you to expand the number of serial ports for a host computer on demand. As long as your host computer supports the TCP/IP protocol, you won't be limited by the host computer's bus limitation (such as ISA or PCI), or lack of drivers for various operating systems.

In addition to providing socket access, the NPort 5200 also comes with a Real COM/TTY driver that transmits all serial signals intact. This means that you can continue using your existing COM/TTY-based software, without needing to invest in additional software.

Three different Socket Modes are available: TCP Server, TCP Client, and UDP Server/Client. The main difference between the TCP and UDP protocols is that TCP guarantees delivery of data by requiring the recipient to send an acknowledgement for every data packet received. UDP does not require this type of verification, making it possible to offer speedier delivery. UDP also allows unicast transmission to on IP, or multicast transmission to groups of IP addresses.

Real COM Mode

The NPort 5200 comes equipped with COM drivers that work with Windows 95/98/ME/NT/2000/XP systems, and also TTY drivers for Linux systems. The driver establishes a transparent connection between host and serial device by mapping the IP:Port of the NPort 5200's serial port to a local COM/TTY port on the host computer. Real COM Mode also supports up to 4 simultaneous connections, so that multiple hosts can collect data from the same serial device at the same time.

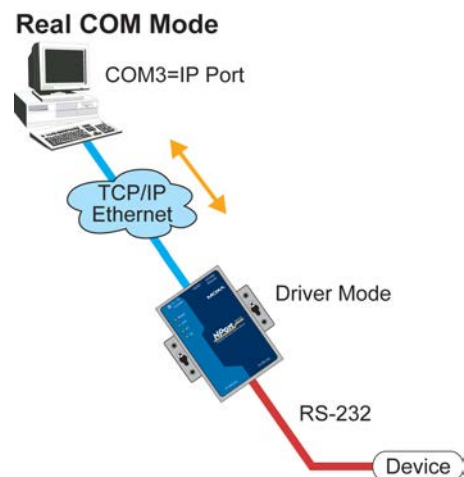



ATTENTION

The driver used for Real COM Mode is bundled with NPort Administrator. The driver is installed on your computer automatically when you install NPort 5200 Administration Suite.

RS-232/422/485 serial communications software that was written for pure serial communications applications. The driver intercepts data sent to the host's COM port, packs it into a TCP/IP packet, and then redirects it through the host's Ethernet card. At the other end of the connection, the NPort 5200 accepts the Ethernet frame, unpacks the TCP/IP packet, and then sends it transparently to the appropriate serial device attached to one of the NPort 5200's serial ports.



ATTENTION

Real COM Mode allows several hosts to have access control to the same NPort 5200. The driver that comes with your NPort 5200 controls host access to attached serial devices by checking the host's IP address. Refer to the **Accessible IP Settings** section of Chapter 5 for more details.

TCP Server Mode

In **TCP Server Mode**, NPort 5200 is configured with a unique IP:Port combination on a TCP/IP network. In this case, NPort 5200 waits passively to be contacted by the host computer. After the host computer establishes a connection with the serial device, it can then proceed with data transmission. TCP Server mode also supports up to 4 simultaneous connections, so that multiple hosts can collect data from the same serial device—at the same time.

As illustrated in the figure, data transmission proceeds as follows:

1. The host requests a connection from the NPort 5200 configured for TCP Server Mode.
2. Once the connection is established, data can be transmitted in both directions—from the host to the NPort 5200, and from the NPort 5200 to the host.

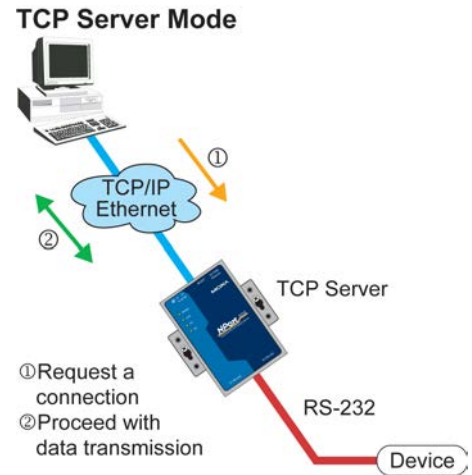

TCP Client Mode

In **TCP Client Mode**, the NPort 5200 can actively establish a TCP connection with a pre-determined host computer when serial data arrives.

After the data has been transferred, the NPort 5200 can disconnect automatically from the host computer by using the **TCP alive check time** or **Inactivity time** settings. Refer to Chapter 5 for detailed configuration instructions.

As illustrated in the figure, data transmission proceeds as follows:

1. The NPort 5200 configured for TCP Client Mode requests a connection from the host.
2. Once the connection is established, data can be transmitted in both directions—from the host to the NPort 5200, and from the NPort 5200 to the host.

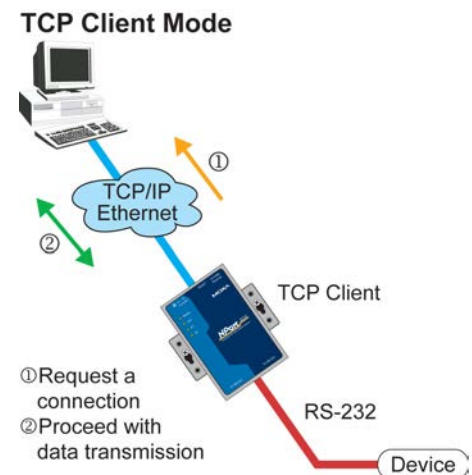

UDP Mode

Compared to TCP communication, UDP is faster and more efficient. In UDP mode, you can unicast or multicast data from the serial device to one or multiple host computers, and the serial device can also receive data from one or multiple host computers, making this mode ideal for message display applications.

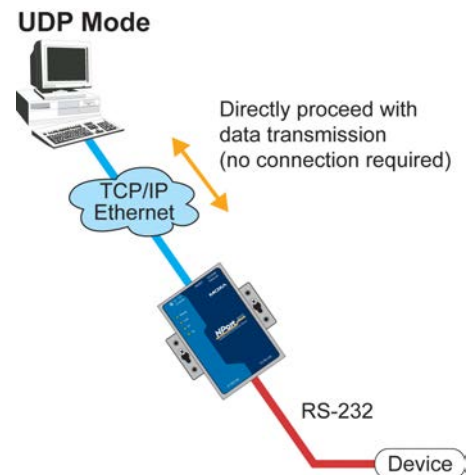

Pair Connection Mode

Pair Connection Mode employs two NPort 5200 in tandem, and can be used to remove the 15-meter distance limitation imposed by the RS-232 interface. One NPort 5200 is connected from its RS-232 port to the COM port of a PC or other type of computer, such as hand-held PDAs that have a serial port, and the serial device is connected to the RS-232 port of the other NPort 5200. The two NPort 5200 are then connected to each other with a cross-over Ethernet cable, both are connected to the same LAN, or in a more advanced setup, they communicate with each other over a WAN (i.e., through one or more routers). Pair Connection Mode transparently transfers both data and modem control signals (although it cannot transmit the DCD signal) between the two NPorts.

Reverse Telnet Mode

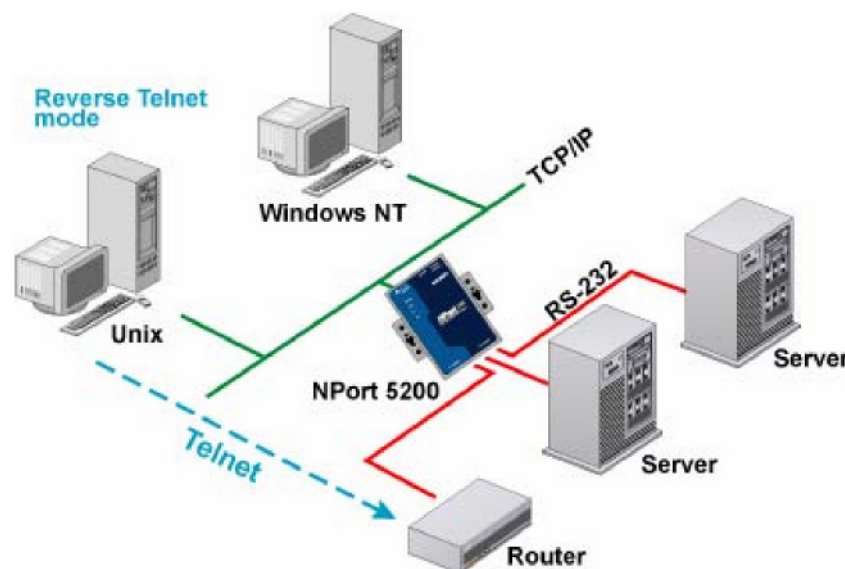

Console management is commonly used upon Console/AUX or COM port of routers, switches, and UPS. Reverse telnet works the same as RAW mode that they only listen to one specific TCP port after booting up, and wait for the host on the network to initiate the connection. The difference is that the RAW mode does not provide conversion function of telnet protocol. If the connected devices need to use CR/LF conversion function when controlling, then users have to choose Reverse telnet mode.

Disabled Mode

When Operation mode is set to Disabled, that particular port will be disabled. Check the “Apply the above settings to all serial ports” to apply this setting to the other port.

Web Console Configuration

The Web Console is the most user-friendly method available to configure NPort 5200. In this chapter, we introduce the Web Console function groups and function definitions.

The following topics are covered in this chapter:

- ❑ **Opening Your Browser**
- ❑ **Basic Settings**
- ❑ **Network Settings**
- ❑ **Serial Settings**
- ❑ **Operating Settings**
 - Real COM Mode
 - TCP Server Mode
 - TCP Client Mode
 - UDP Mode
 - Pair Connection Mode
 - Reverse Telnet Mode
 - Disabled Mode
- ❑ **Accessible IP Settings**
- ❑ **Auto Warning Settings**
 - Auto warning: Email and SNMP trap
 - Event Type
- ❑ **Monitor**
 - Monitor Line
 - Monitor Async
 - Monitor Async-Settings
- ❑ **Change Password**
- ❑ **Load Factory Default**

Opening Your Browser

1. Open your browser with the cookie function enabled. (To enable your browser for cookies, right click on your desktop Internet Explorer icon, select Properties, click on the Security tab, and then select the three Enable options as shown in the figure below.)

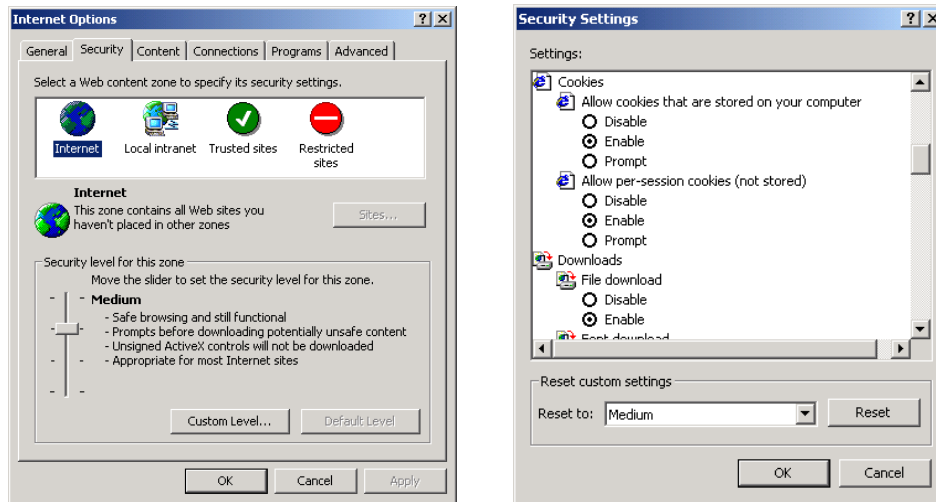

2. Type **192.168.127.254** in the **Address** input box (use the correct IP address if different from the default), and then press **Enter**.
3. Input the password if prompted. The password is transmitted with MD5 encryption over the Ethernet. Note that you will not be prompted to enter the password if the NPort 5200 is not password protected.

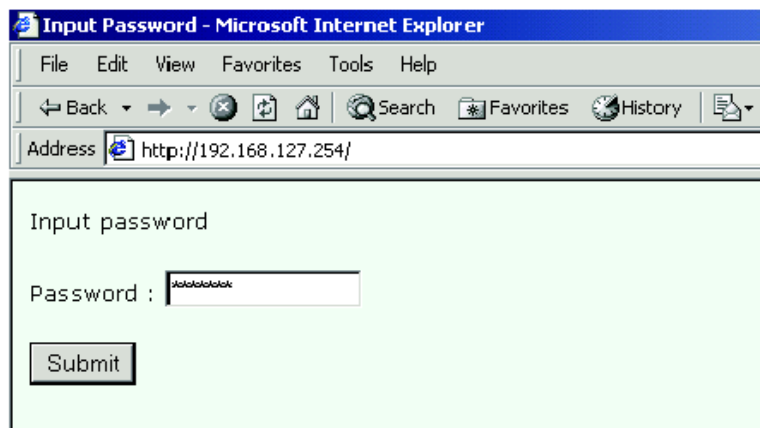

ATTENTION

If you use web browsers other than Explorer, remember to Enable the functions to “allow cookies that are stored on your computer” or “allow per-session cookies.”

Note that NPort 5200 only uses cookies for “password” transmission.



ATTENTION

Refer to Chapter 3, **Initial IP Address Configuration**, to see how to configure the IP address. Examples shown in this chapter use the Factory Default IP address (192.168.127.254).

4. The NPort 5200 homepage will open next. On this page, you can see a brief description of the Web Console's nine function groups.



ATTENTION

If you can't remember the password, the **ONLY** way to start configuring the NPort 5200 is to load factory defaults by using the Reset button located near the NPort 5200's RJ45 Ethernet port.

Remember to use NPort Administrator to export the configuration file when you have finished the configuration. After using the Reset button to load factory defaults, your configuration can be easily reloaded into the NPort 5200 by using the NPort Administrator Import function. Refer to Chapter 6 for more details about using the Export and Import functions.



ATTENTION

If your NPort 5200 application requires using password protection, you must enable the cookie function in your browser. If the cookie function is disabled, you will not be allowed to enter the Web Console Screen.

Basic Settings

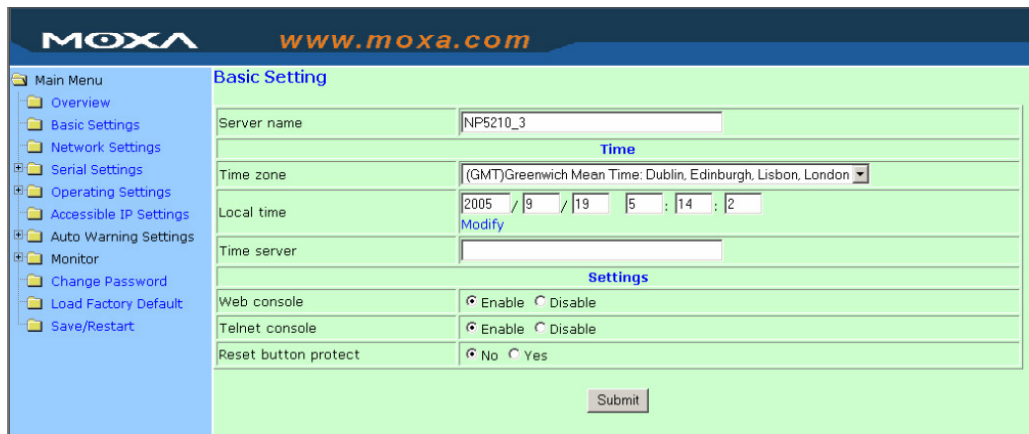

Server name

Setting	Factory Default	Necessity
1 to 39 characters	[model name]_[Serial No.]	Optional

This option is useful for specifying the location or application of different NPort 5200s.

Time

NPort 5200 has a built-in Real-Time Clock for time calibration functions. Real-time information can be added to Auto warning "Email" or "SNMP Trap" messages.



ATTENTION

First time users should select the time zone first. The Console will display the "real time" according to the time zone compared to GMT.
 If you would like to modify the real time clock, select "Local time." NPort 5200's firmware will modify the GMT time according to the Time Zone.

Time zone

Setting	Factory Default	Necessity
User selectable time zone	GMT (Greenwich Mean Time)	Required

Local time

Setting	Factory Default	Necessity
User adjustable time (1900/1/1 to 2037/12/31)	GMT (Greenwich Mean Time)	Required

Click on the **Modify** button to open the **Modify time settings** window to modify the time.



Time server

Setting	Factory Default	Necessity
IP Address or Domain Name (E.g., 192.168.1.1, time.stdtime.gov.tw, or time.nist.gov)	blank	Optional

The NPort 5200 uses SNTP (RFC-1769) for auto time calibration.

Input the correct "Time server" IP address or domain name. Once NPort 5200 is configured with the correct Time server address, NPort 5200 will request time information from the "Time server" every 10 minutes.

Web/Telnet Console

The "Disable" option for "Web Console" and "Telnet Console" is included for security reasons. In some cases, you may want to disable one or both of these console utilities as an extra precaution to prevent unauthorized users from accessing your NPort 5200. The factory default for both Web console and Telnet console is **Enable**.

Web console

Setting	Factory Default	Necessity
Enable or Disable	Enable	Required

Telnet console

Setting	Factory Default	Necessity
Enable or Disable	Enable	Required

**ATTENTION**

If you disable both the "Web console" and "Telnet console," you can still use NPort Administrator to configure NPort 5200 either locally or remotely over the network. Refer to Chapter 6 for more details.

Reset button protect

Setting	Factory Default	Necessity
No or Yes	No	Required

NOTE: Select the **Yes** option to allow limited use of the Reset Button. In this case, the Reset Button can be used for only 60 seconds. I.e., 60 sec. after booting up, the Reset Button will be disabled automatically.

Network Settings



You must assign a valid IP address to the NPort 5200 before it will work in your network environment. Your network system administrator should provide you with an IP address and related settings for your network. The IP address must be unique within the network (otherwise, the NPort 5200 will not have a valid connection to the network). First time users can refer to Chapter 3, **Initial IP Address Configuration**, for more information.

You can choose from four possible **IP Configuration** modes—**Static**, **DHCP**, **DHCP/BOOTP**, and **BOOTP**—located under the web console screen’s IP configuration drop-down box.

Method	Function Definition
Static	User defined IP address, Netmask, Gateway.
DHCP	DHCP Server assigned IP address, Netmask, Gateway, DNS, and Time Server
DHCP/BOOTP	DHCP Server assigned IP address, Netmask, Gateway, DNS, and Time Server, or BOOTP Server assigned IP address (if the DHCP Server does not respond)
BOOTP	BOOTP Server assigns IP address

IP Address

Setting	Factory Default	Necessity
E.g., 192.168.1.1 (IP addresses of the form x.x.x.0 and x.x.x.255 are invalid.)	192.168.127.254	Required

An IP address is a number assigned to a network device (such as a computer) as a permanent address on the network. Computers use the IP address to identify and talk to each other over the network. Choose a proper IP address that is unique and valid in your network environment.

Netmask

Setting	Factory Default	Necessity
E.g., 255.255.255.0	255.255.255.0	Required

A netmask identifies a local area network. When a packet is sent out over the network, the NPort 5200 will use the subnet mask to check whether the destination TCP/IP host specified in the packet is on the local network

segment. If the address is on the same network segment as the NPort 5200, a connection is established directly from the NPort 5200. Otherwise, an attempt is made to establish a connection through the given default gateway.

Gateway

Setting	Factory Default	Necessity
E.g., 192.168.1.1	blank	Optional

The gateway IP address identifies a network gateway that acts as an entrance to another network. Usually, the computers that control traffic within the network or at the local Internet service provider are gateway nodes. The NPort 5200 needs to know the IP address of the default gateway computer in order to communicate with the hosts outside the local network environment. For correct gateway IP address information, consult your network administrator.

IP Configuration

Setting	Factory Default	Necessity
Static, DHCP, DHCP/BOOTP, BOOTP	Static	Required



ATTENTION

In Dynamic IP environments, the firmware will retry 3 times every 30 seconds until network settings are assigned by the DHCP or BOOTP server. The Timeout for each try increases from 1 second, to 3 seconds, to 5 seconds.

If the DHCP/BOOTP Server is unavailable, the firmware will use the default IP address (192.168.127.254), Netmask, and Gateway for IP settings.

DNS server 1 / DNS server 2

Setting	Factory Default	Necessity
E.g., 192.168.1.1 (IP addresses of the form x.x.x.0 and x.x.x.255 are invalid DNS server settings.)	blank	Optional

When the user wants to visit a particular website, the computer requests the website's IP address from a Domain Name System (DNS) server, and then the computer uses that IP address to connect to the web server. DNS is used to identify Internet domain names, and to translate domain names into IP addresses. A domain name is an alphanumeric name, such as moxa.com. A DNS server is a host that translates this kind of text-based domain name into the numeric IP address used to establish a TCP/IP connection.

In order to use NPort 5200's DNS feature, you need to configure the DNS server. Doing so allows NPort 5200 to use a host's domain name to access the host. NPort 5200 provides **DNS server 1** and **DNS server 2** configuration items to configure the IP address of the DNS server. DNS Server 2 is used when DNS sever 1 is unavailable.

NPort 5200 plays the role of DNS client, in the sense that the NPort 5200 will actively query the DNS server for the IP address associated with a particular domain name. NPort 5200 functions that support domain name are **Time server**, **Destination IP Address in TCP Client mode**, **Mail Server**, **SNMP trap server**, and **Auto report to IP**.

SNMP Settings

Community Name

Setting	Factory Default	Necessity
1 to 39 characters (E.g., Support, 886-89191230 #300)	public	Optional

A community name is a plain-text password mechanism that is used to authenticate queries weakly to agents of managed network devices.

Contact

Setting	Factory Default	Necessity
1 to 39 characters (E.g., Support, 886-89191230 #300)	blank	Optional

The SNMP contact information usually includes an emergency contact name and telephone or pager number.

Location

Setting	Factory Default	Necessity
1 to 39 characters (E.g., Floor 1, office 2)	blank	Optional

Specify the location of SNMP agents, such as NPort 5200. This string is usually set to the street address where the NPort 5200 is physically located.

IP Address Report

When NPort 5200 Series products are used in a dynamic IP environment, users must spend more time with IP management tasks. For example, if NPort 5200 is set up as a server (TCP or UDP), then the host, which acts as a client, must know the IP address of the server. If the DHCP server assigns a new IP address to NPort 5200, the host must have some way of determining NPort 5200's new IP address.

NPort 5200 device servers help out by reporting their IP address periodically to the IP location server, in case the dynamic IP has changed. The parameters shown below are used to configure the Auto IP report function. There are two ways to develop an "Auto IP report Server" to receive NPort 5200's Auto IP report.

1. Use Device Server Administrator's IP Address Report function.
2. "Auto IP report protocol," which can receive the Auto IP report automatically on a regular basis, is also available to help you develop your own software. Refer to Appendix E for the "Auto IP report protocol."

Auto report to IP

Setting	Factory Default	Necessity
E.g., 192.168.1.1 or URL (IP addresses of the form x.x.x.0 and x.x.x.255 are invalid.)	blank	Optional

Reports generated by the Auto report function will be sent to this IP address automatically.

Auto report to UDP port

Setting	Factory Default	Necessity
E.g., 4002	4002	Optional

Auto report period

Setting	Factory Default	Necessity
Time interval (in seconds)	10	Optional

Serial Settings

Click on **Serial Settings**, located under **Main Menu**, to display serial port settings for ports 1 and 2.

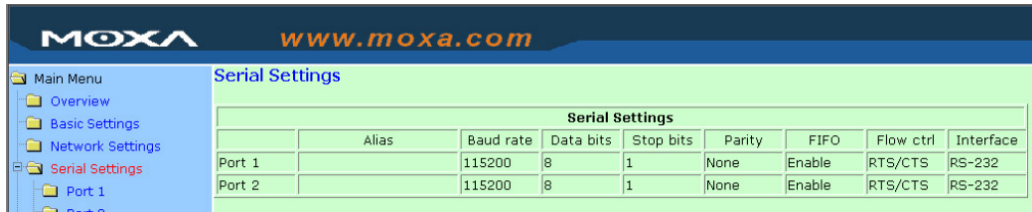

To modify serial settings for a particular port, click on either **Port 1** or **Port 2** under **Serial Settings**, located under **Main Menu** on the left side of the browser window.

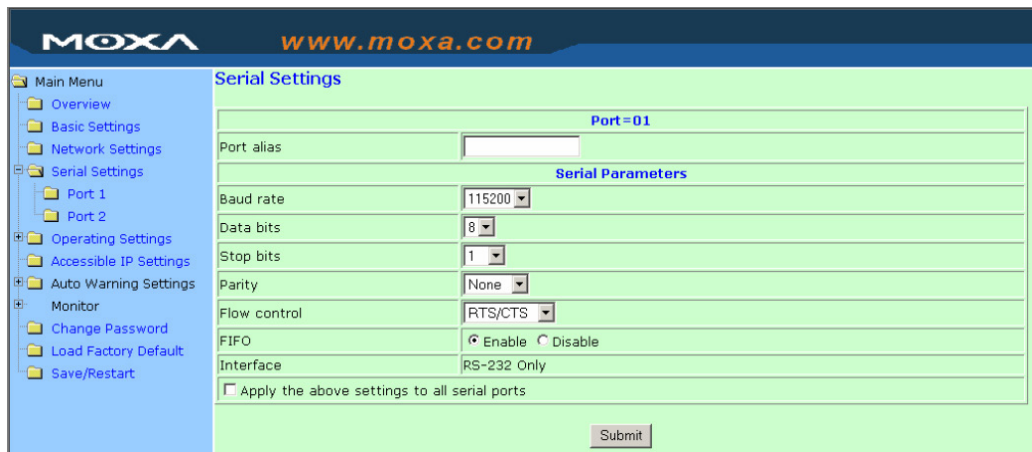

Port alias

Setting	Factory Default	Necessity
1 to 15 characters (E.g., PLC-No.1)	blank	Optional

“Port alias” is included to allow easy identification of the serial devices that are connected to NPort 5200’s serial port.

Serial Parameters



ATTENTION

Check your serial device’s user’s manual to determine the proper settings for the device’s serial communication parameters. Use these settings to configure NPort 5200’s serial parameters.

Baud rate

Setting	Factory Default	Necessity
110 bps to 230.4 Kbps	115.2 Kbps	Required

Data bits

Setting	Factory Default	Necessity
5, 6, 7, 8	8	Required

When the user sets Data bits to 5 bits, the Stop bits setting will automatically change to 1.5 bits.

Stop bits

Setting	Factory Default	Necessity
1, 2	1	Required

Stop bits will be set to 1.5 when Data bits is set to 5 bits.

Parity

Setting	Factory Default	Necessity
None, Even, Odd, Space, Mark	None	Required

Flow control

Setting	Factory Default	Necessity
None, RTS/CTS, DTR/DSR, Xon/Xoff	RTS/CTS	Required

FIFO

Setting	Factory Default	Necessity
Enable, Disable	Enable	Required

NPort 5200's serial ports provide a 16-byte FIFO both in the Tx and Rx directions. To prevent data loss during communication, disable the FIFO setting when your serial device does not have a FIFO.

Interface

Model	Port	Settings	Factory Default	Necessity
NPort 5210	1 and 2	RS-232	RS-232	N/A
NPort 5230	1	RS-232	RS-232	Required
	2	RS-422, 2-wire RS-485, 4-wire RS-485	4-wire RS-485	
NPort 5232/5232I	1 and 2	RS-422, 2-wire RS-485, 4-wire RS-485	4-wire RS-485	Required

Operating Settings

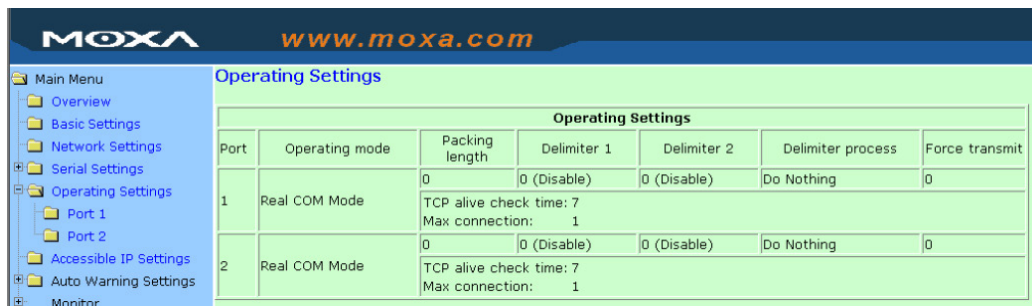

Click on **Operating Settings**, located under **Main Menu**, to display the operating settings for both of NPort 5200's serial ports.

Real COM Mode

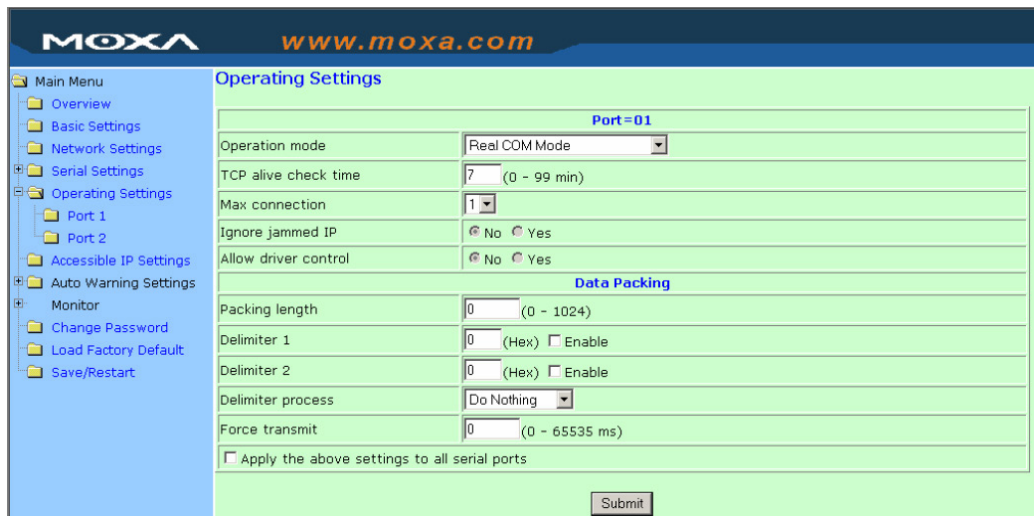

TCP alive check time

Setting	Factory Default	Necessity
0 to 99 min	7 min	Required

0 min: TCP connection is not closed due to an idle TCP connection.

1 to 99 min: NPort 5200 automatically closes the TCP connection if there is no TCP activity for the given time. After the connection is closed, the NPort 5200 starts listening for another Real COM driver connection from another host.

Max connection

Setting	Factory Default	Necessity
1, 2, 3, 4	1	Required

Max connection is usually used when the user needs to receive data from different hosts simultaneously. The factory default is 1. In this case, only one specific host can access this port of the NPort 5200, and the Real COM driver on that host will have full control over the port.

Max. Connection 1:

Allows only 1 host's Real COM driver to open the specific NPort 5200 serial port.

Max Connection 2 to 4:

Allows 2 to 4 host's Real COM drivers to open the specific NPort 5200 serial port, at the same time. When multiple hosts' Real COM drivers open the serial port at the same time, the COM driver only provides a pure data tunnel without control ability. That is, this serial port parameter will use the firmware settings, instead of depending on your application program (AP).

Application software that is based on the COM driver will receive a driver response of "success" when the software uses any of the Win32 API functions. The firmware will only send the data back to the driver on the host.

Data will be sent first-in-first-out when data comes into the NPort 5200 from the Ethernet interface.



ATTENTION

When Max connection is set to 2, 3, or 4, this means that the NPort 5200 will be using a "multi connection application" (i.e., 2, 3, or 4 hosts are allowed access to the port at the same time). When using a multi connection application, the NPort 5200 will use the serial communication parameters set in the console. All of the hosts connected to that port must use the same serial settings. If one of the hosts opens the COM port with parameters that are different from the NPort 5200's console setting, data communication may not work properly.

Ignore jammed IP

Setting	Factory Default	Necessity
No or Yes	No	Required

For previous versions of NPort 5200, when Max connections > 1, and the serial device is transmitting data, if any one of the connected hosts was not responding NPort 5200 would wait until the data had been transmitted successfully before transmitting the second group of data to all hosts. For the current version of NPort 5200, if you select Yes for "Ignore jammed IP," the host that is not responding will be ignored, but the data will still be transmitted to the other hosts.

Allow driver control

Setting	Factory Default	Necessity
No or Yes	No	Required

If "max connection" is greater than 1, NPort will ignore driver control commands from all connected hosts. However, if you set "Allow driver control" to YES, control commands will be accepted. Note that since NPort 5200 may get configuration changes from multiple hosts, the most recent command received will take precedence.

Packing length

Setting	Factory Default	Necessity
0 to 1024	0	Required

Default = 0, The Delimiter Process will be followed, regardless of the length of the data packet. If the data length (in bytes) matches the configured value, the data will be forced out. The data length can be configured for 0 to 1024 bytes. Set to 0 if you do not need to limit the length.

Delimiter 1

Setting	Factory Default	Necessity
00 to FF (hex)	0	Required

Delimiter 2

Setting	Factory Default	Necessity
00 to FF (hex)	0	Required

Once the NPort 5200 receives both delimiters through its serial port, it immediately packs all data currently in its buffer and sends it to the NPort 5200's Ethernet port.

**ATTENTION**

Delimiter 2 is optional. If left blank, then Delimiter 1 alone trips clearing of the buffer. If the size of the serial data received is greater than 1 KB, the NPort 5200 will automatically pack the data and send it to the Ethernet. However, to use the delimiter function, you must at least enable Delimiter 1. If Delimiter 1 is left blank and Delimiter 2 is enabled, the delimiter function will not work properly.

Delimiter process

Setting	Factory Default	Necessity
Do nothing, Delimiter + 1, Delimiter + 2, Strip Delimiter	Do Nothing	Required

When [Delimiter + 1] or [Delimiter + 2] is selected, the data will be transmitted when an additional byte (for Delimiter +1), or an additional 2 bytes (for Delimiter +2) of data is received after receiving the Delimiter.

When [Strip Delimiter] is selected, when the Delimiter is received, the Delimiter is deleted (i.e., stripped), and the remaining data is transmitted.

When [Do nothing] is selected, the data will be transmitted when the Delimiter is received.

Force transmit

Setting	Factory Default	Necessity
0 to 65535 ms	0 ms	Required

0: Disable the force transmit timeout.

1 to 65535: Forces the NPort 5200's TCP/IP protocol software to try to pack serial data received during the specified time into the same data frame.

This parameter defines the time interval during which NPort 5200 fetches the serial data from its internal buffer. If data is incoming through the serial port, NPort 5200 stores the data in the internal buffer. NPort 5200 transmits data stored in the buffer via TCP/IP, but only if the internal buffer is full or if the Force transmit time interval reaches the time specified under Force transmit timeout.

The optimal Force transmit timeout depends on your application, but it must be at least larger than one character interval within the specified baud rate. For example, assume that the serial port is set to 1200 bps, 8 data bits, 1 stop bit, and no parity. In this case, the total number of bits needed to send a character is 10 bits, and the time required to transfer one character is

$$(10 \text{ (bits)} / 1200 \text{ (bits/s)}) * 1000 \text{ (ms/s)} = 8.3 \text{ ms.}$$

Therefore, you should set Force transmit timeout to be larger than 8.3 ms, so in this case, it must be greater than or equal to 10 ms.

If the user wants to send a series of characters in the same packet, the serial device attached to NPort 5200 should send that series of characters during a time interval less than the Force transmit timeout for NPort 5200, and the total length of data must be less than or equal to NPort 5200's internal buffer size. The serial communication buffer size for NPort 5200 is 1 KB per port.

TCP Server Mode

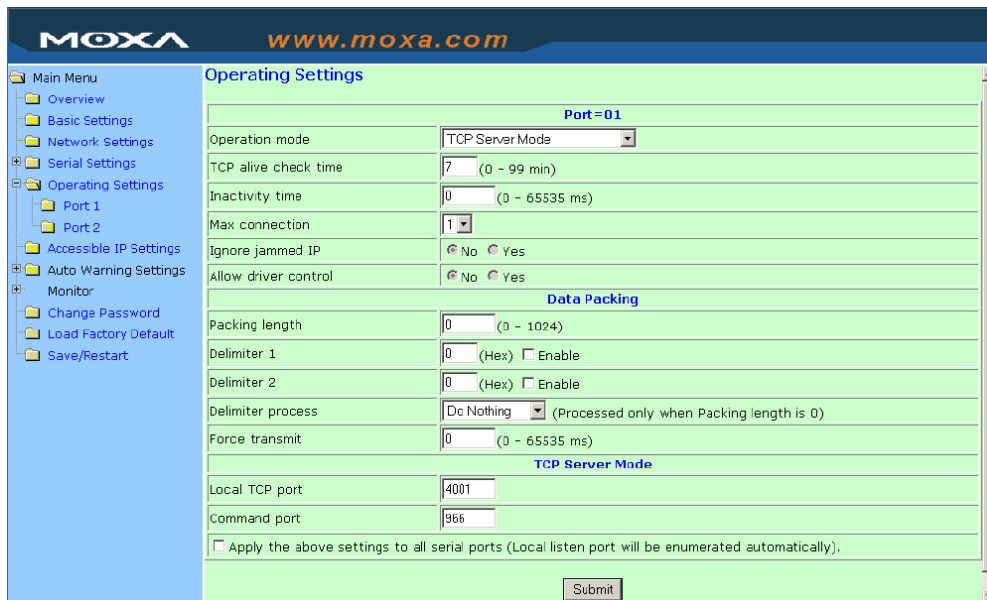

TCP alive check time

Setting	Factory Default	Necessity
0 to 99 min	7 min	Optional

0 min: TCP connection is not closed due to an idle TCP connection.

1 to 99 min: The NPort 5200 automatically closes the TCP connection if there is no TCP activity for the given time. After the connection is closed, the NPort 5200 starts listening for another host's TCP connection.

Inactivity time

Setting	Factory Default	Necessity
0 to 65535 ms	0 ms	Optional

0 ms: TCP connection is not closed due to an idle serial line.

1-65535 ms: The NPort 5200 automatically closes the TCP connection if there is no serial data activity for the given time. After the connection is closed, the NPort 5200 starts listening for another host's TCP connection.

This parameter defines the maintenance status as Closed or Listen for the TCP connection. The connection is closed if data is not incoming or outgoing through the serial port during the specific Inactivity time.

If the Inactivity time is set to 0, the current TCP connection is kept active until a connection close request is received. Although Inactivity time is disabled, the NPort 5200 will check the connection status between the NPort 5200 and remote host by sending "keep alive" packets periodically. If the remote host does not respond to the packet, NPort 5200 assumes that the connection was closed down unintentionally. NPort 5200 will then force the existing TCP connection to close.



ATTENTION

The Inactivity time should at least be larger than Force transmit timeout. To prevent the unintended loss of data due to the session being disconnected, it is highly recommended that this value is set large enough so that the intended data transfer can be completed.

Max Connection

Setting	Factory Default	Necessity
1, 2, 3, 4	1	Required

Max Connection is usually used when the user needs to receive data from different hosts simultaneously. The factory default only allows 1 connection at a time.

Max. Connection 1:

NPort 5200 only allows 1 host to open the TCP connection to the specific serial port.

Max Connection 2 to 4:

Allows 2 to 4 host's TCP connection request to open this NPort 5200 serial port, at the same time. When multiple hosts establish a TCP connection to the specific serial port at the same time, NPort 5200 will duplicate the serial data and transmit to all of the hosts. Ethernet data is sent on a first-in-first-out basis to the serial port when data comes into NPort 5200 from the Ethernet interface.

Ignore jammed IP

Setting	Factory Default	Necessity
No or Yes	No	Required

For previous versions of NPort 5200, when Max connections > 1, and the serial device is transmitting data, if any one of the connected hosts was not responding NPort 5200 would wait until the data had been transmitted successfully before transmitting the second group of data to all hosts. For the current version of NPort 5200, if you select Yes for "Ignore jammed IP," the host that is not responding will be ignored, but the data will still be transmitted to the other hosts.

Allow driver control

Setting	Factory Default	Necessity
No or Yes	No	Required

If "max connection" is greater than 1, the NPort will ignore driver control commands from all connected hosts. However, if you set "Allow driver control" to YES, control commands will be accepted. Note that since the NPort 5200 may get configuration changes from multiple hosts, the most recent command received will take precedence.

Packing length

Setting	Factory Default	Necessity
0 to 1024	0	Optional

Default = 0, The Delimiter Process will be followed, regardless of the length of the data packet. If the data length (in bytes) matches the configured value, the data will be forced out. The data length can be configured for 0 to 1024 bytes. Set to 0 if you do not need to limit the length.

Delimiter 1

Setting	Factory Default	Necessity
00 to FF	blank	Optional

Delimiter 2

Setting	Factory Default	Necessity
00 to FF	blank	Optional

Once the NPort 5200 receives both delimiters through its serial port, it immediately packs all data currently in its buffer and sends it out the NPort 5200's Ethernet port.



ATTENTION

Delimiter 2 is optional. If left blank, then Delimiter 1 alone trips clearing of the buffer. If the size of the serial data received is greater than 1 KB, the NPort 5200 will automatically pack the data and send it to the Ethernet. However, to use the delimiter function, you must at least enable Delimiter 1. If Delimiter 1 is left blank and Delimiter 2 is enabled, the delimiter function will not work properly.

Delimiter process

Setting	Factory Default	Necessity
Do nothing Delimiter + 1, Delimiter + 2 Strip Delimiter	Do Nothing	Optional

When [Delimiter + 1] or [Delimiter + 2] is selected, the data will be transmitted when an additional byte (for Delimiter +1), or an additional 2 bytes (for Delimiter +2) of data is received after receiving the Delimiter.

When [Strip Delimiter] is selected, when the Delimiter is received, the Delimiter is deleted (i.e., stripped), and the remaining data is transmitted.

When [Do nothing] is selected, the data will be transmitted when the Delimiter is received.

Force transmit

Setting	Factory Default	Necessity
0 to 65535 ms	0 ms	Optional

0: Disable the force transmit timeout.

1 to 65535: Forces the NPort 5200's TCP/IP protocol software to try to pack serial data received during the specified time into the same data frame.

This parameter defines the time interval during which NPort 5200 fetches the serial data from its internal buffer. If data is incoming through the serial port, NPort 5200 stores the data in the internal buffer. NPort 5200 transmits data stored in the buffer via TCP/IP, but only if the internal buffer is full or if the Force transmit time interval reaches the time specified under Force transmit timeout.

The optimal Force transmit timeout depends on your application, but it must be at least larger than one character interval within the specified baud rate. For example, assume that the serial port is set to 1200 bps, 8 data bits, 1 stop bit, and no for parity. In this case, the total number of bits needed to send a character is 10 bits, and the time required to transfer one character is

$$(10 \text{ (bits)} / 1200 \text{ (bits/s)}) * 1000 \text{ (ms/s)} = 8.3 \text{ ms.}$$

Therefore, you should set Force transmit timeout to be larger than 8.3 ms, so in this case, it must be greater than or equal to 10 ms.

If the user wants to send a series of characters in the same packet, the serial device attached to NPort 5200 should send that series of characters during a time interval less than the Force transmit timeout for NPort 5200, and the total length of data must be less than or equal to NPort 5200's internal buffer size. The serial communication buffer size for NPort 5200 is 1 KB per port.

Local TCP port

Setting	Factory Default	Necessity
1 to 65535	4001	Required

The "Local TCP port" is the TCP port that NPort 5200 uses to listen to connections, and that other devices must use to contact NPort 5200. To avoid conflicts with commonly used TCP port numbers, the default is set to 4001.

Command port

Setting	Factory Default	Necessity
1 to 65535	966	Optional

The "Command port" is a listen TCP port for IP-Serial Lib commands from the host. In order to prevent a TCP port conflict with other applications, the user can set the Command port to another port if needed. IP-Serial Lib will automatically check the Command Port on NPort 5200 so that the user does not need to configure the program.

TCP Client Mode

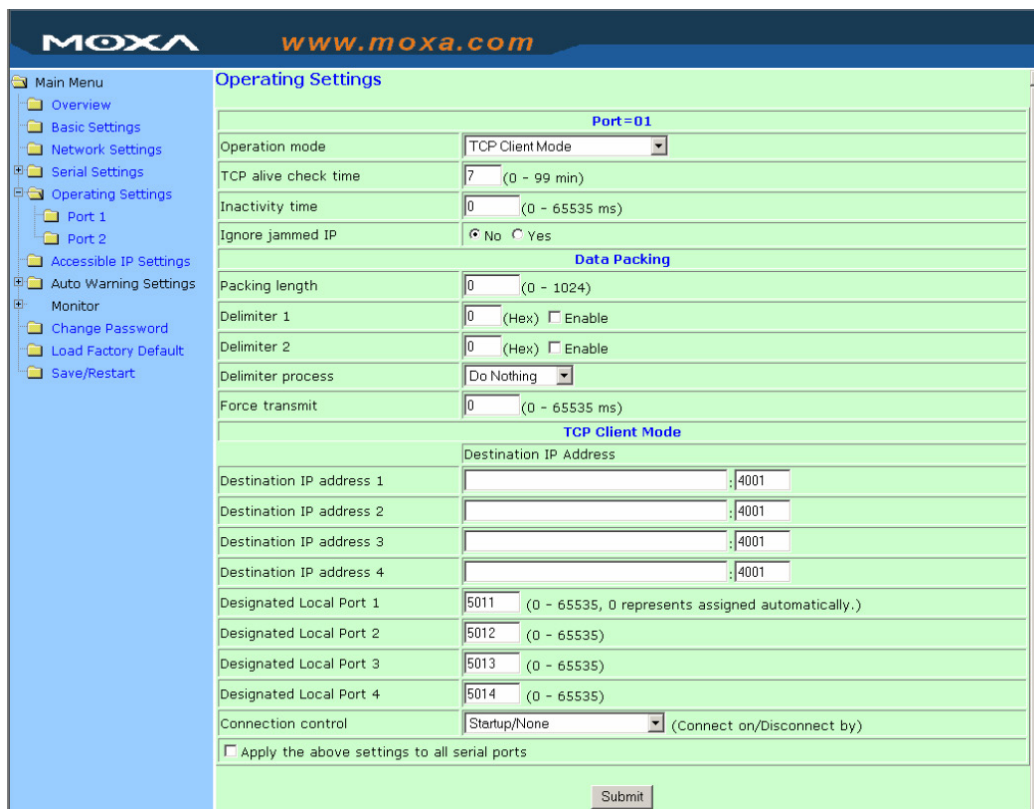

TCP alive check time

Setting	Factory Default	Necessity
0 to 99 min	7 min	Optional

0 min: TCP connection is not closed due to an idle TCP connection.

1 to 99 min: NPort 5200 closes the TCP connection automatically if there is no TCP activity for the given time.

Inactivity time

Setting	Factory Default	Necessity
0 to 65535 ms	0 ms	Optional

0 ms: TCP connection is not closed due to an idle serial line.

0-65535 ms: NPort 5200 closes the TCP connection automatically if there is no serial data activity for the given time.

This parameter defines the maintenance status as Closed or Listen for the TCP connection. The connection is closed if data is not incoming or outgoing through the serial port during the specified Inactivity time.

If the Inactivity time is set to 0, the current TCP connection is kept active until a connection close request is received. Although Inactivity time is disabled, the NPort 5200 will check the connection status between the NPort 5200 and remote host by sending "keep alive" packets periodically. If the remote host does not respond to the packet, NPort 5200 assumes that the connection was closed down unintentionally. NPort 5200 will then force the existing TCP connection to close.

**ATTENTION**

The Inactivity time should at least be set larger than that of Force transmit timeout. To prevent the unintended loss of data due to the session being disconnected, it is highly recommended that this value is set large enough so that the intended data transfer is completed.

**ATTENTION**

Inactivity time is ONLY active when "TCP connect on" is set to "Any character."

Ignore jammed IP

Setting	Factory Default	Necessity
No or Yes	No	Optional

For previous versions of NPort 5200, when Max connections > 1, and the serial device is transmitting data, if any one of the connected hosts was not responding NPort 5200 would wait until the data had been transmitted successfully before transmitting the second group of data to all hosts. For the current version of NPort 5200, if you select Yes for "Ignore jammed IP," the host that is not responding will be ignored, but the data will still be transmitted to the other hosts.

Packing length

Setting	Factory Default	Necessity
0 to 1024	0	Optional

Default = 0, The Delimiter Process will be followed, regardless of the length of the data packet. If the data length (in bytes) matches the configured value, the data will be forced out. The data length can be configured for 0 to 1024 bytes. Set to 0 if you do not need to limit the length.

Delimiter 1

Setting	Factory Default	Necessity
00 to FF (hex)	blank	Optional

Delimiter 2

Setting	Factory Default	Necessity
00 to FF (hex)	blank	Optional

Once the NPort 5200 receives both delimiters through its serial port, it immediately packs all data currently in its buffer and sends it to the NPort 5200's Ethernet port.

**ATTENTION**

Delimiter 2 is optional. If left blank, then Delimiter 1 alone trips clearing of the buffer. If the size of the serial data received is greater than 1 KB, the NPort 5200 will automatically pack the data and send it to the Ethernet. However, to use the delimiter function, you must at least enable Delimiter 1. If Delimiter 1 is left blank and Delimiter 2 is enabled, the delimiter function will not work properly.

Delimiter process

Setting	Factory Default	Necessity
Do nothing, Delimiter + 1, Delimiter + 2, Strip Delimiter	Do Nothing	Required

When [Delimiter + 1] or [Delimiter + 2] is selected, the data will be transmitted when an additional byte (for Delimiter +1), or an additional 2 bytes (for Delimiter +2) of data is received after receiving the Delimiter.

When [Strip Delimiter] is selected, when the Delimiter is received, the Delimiter is deleted (i.e., stripped), and the remaining data is transmitted.

When [Do nothing] is selected, the data will be transmitted when the Delimiter is received.

Force transmit

Setting	Factory Default	Necessity
0 to 65535 ms	0 ms	Required

0: Disable the force transmit timeout.

1 to 65535: Forces the NPort 5200's TCP/IP protocol software to try to pack serial data received during the specified time into the same data frame.

This parameter defines the time interval during which NPort 5200 fetches the serial data from its internal buffer. If data is incoming through the serial port, NPort 5200 stores the data in the internal buffer. NPort 5200 transmits data stored in the buffer via TCP/IP, but only if the internal buffer is full or if the Force transmit time interval reaches the time specified under Force transmit timeout.

The optimal Force transmit timeout depends on your application, but it must be at least larger than one character interval within the specified baud rate. For example, assume that the serial port is set to 1200 bps, 8 data bits, 1 stop bit, and no parity. In this case, the total number of bits needed to send a character is 10 bits, and the time required to transfer one character is

$$(10 \text{ (bits)} / 1200 \text{ (bits/s)}) * 1000 \text{ (ms/s)} = 8.3 \text{ ms.}$$

Therefore, you should set Force transmit timeout to be larger than 8.3 ms, so in this case, it must be greater than or equal to 10 ms.

If the user wants to send a series of characters in the same packet, the serial device attached to NPort 5200 should send that series of characters during a time interval less than the Force transmit timeout for NPort 5200, and the total length of data must be less than or equal to NPort 5200's internal buffer size. The serial communication buffer size for NPort 5200 is 1 KB per port.

Destination IP address 1

Setting	Factory Default	Necessity
IP address or Domain Name (E.g., 192.168.1.1)	blank	Optional

Allows NPort 5200 to connect actively to the remote host whose IP address is set by this parameter.

Destination IP address 2/3/4

Setting	Factory Default	Necessity
IP address or Domain Name (E.g., 192.168.1.1)	blank	Optional

Allows the NPort 5200 to connect actively to the remote host whose IP address is set by this parameter.



ATTENTION

Up to 4 connections can be established between the NPort 5200 and hosts. The connection speed or throughput may be low if one of the four connections is slow, since the 1 slow connection will slow down the other 3 connections.



ATTENTION

The "Destination IP address" parameter can use both IP address and Domain Name. For some applications, the user may need to send the data actively to the remote destination domain name.

Designated Local Port 1/2/3/4

Setting	Factory Default	Necessity
TCP Port No.	5011 (Port 1) 5012 (Port 2) 5013 (Port 3) 5014 (Port 4)	Required

Connection control

Setting	Factory Default	Necessity
Startup/None, Any Character/None, Any Character/ Inactivity Time, DSR ON/DSR OFF, DSR ON/None, DCD ON/DCD OFF, DCD ON/None	Startup/None	Required

The meaning of each of the above settings is given in the table below. In general, both the Connect condition and Disconnect condition are given.

Connect/Disconnect	Description
Startup/None (default)	A TCP connection will be established on startup, and will remain active indefinitely.
Any Character/None	A TCP connection will be established when any character is received from the serial interface, and will remain active indefinitely.
Any Character/ Inactivity Time	A TCP connection will be established when any character is received from the serial interface, and will be disconnected when the Inactivity time out is reached.
DSR On/DSR Off	A TCP connection will be established when a DSR "On" signal is received, and will be disconnected when a DSR "Off" signal is received.
DSR On/None	A TCP connection will be established when a DSR "On" signal is received, and will remain active indefinitely.
DCD On/DCD Off	A TCP connection will be established when a DCD "On" signal is received, and will be disconnected when a DCD "Off" signal is received.
DCD On/None	A TCP connection will be established when a DCD "On" signal is received, and will remain active indefinitely.

UDP Mode

The screenshot shows the MOXA web console configuration page for UDP Mode. The left sidebar contains a navigation menu with options like Overview, Basic Settings, Network Settings, Serial Settings, Operating Settings, Accessible IP Settings, Auto Warning Settings, Monitor, Change Password, Load Factory Default, and Save/Restart. The main content area is titled 'Operating Settings' and shows configuration for 'Port=01'. Under 'Data Packing', there are fields for Packing length (0), Delimiter 1 (0), Delimiter 2 (0), Delimiter process (Do Nothing), and Force transmit (0). Under 'UDP Mode', there are four Destination IP address fields (all set to 4001) and a Local Listen port field (set to 4001). A checkbox at the bottom allows applying settings to all serial ports. A 'Submit' button is at the bottom right.

Packing length

Setting	Factory Default	Necessity
0 to 1024	0	Required

Default = 0, The Delimiter Process will be followed, regardless of the length of the data packet. If the data length (in bytes) matches the configured value, the data will be forced out. The data length can be configured for 0 to 1024 bytes. Set to 0 if you do not need to limit the length.

Delimiter 1

Setting	Factory Default	Necessity
00 to FF	blank	Required

Delimiter 2

Setting	Factory Default	Necessity
00 to FF	blank	Required

Once the NPort 5200 receives both delimiters through its serial port, it immediately packs all data currently in its buffer and sends it out the NPort 5200's Ethernet port.



ATTENTION

Delimiter 2 is optional. If left blank, then Delimiter 1 alone trips clearing of the buffer. If the size of the serial data received is greater than 1 KB, the NPort 5200 will automatically pack the data and send it to the Ethernet. However, to use the delimiter function, you must at least enable Delimiter 1. If Delimiter 1 is left blank and Delimiter 2 is enabled, the delimiter function will not work properly.

Delimiter process

Setting	Factory Default	Necessity
Do nothing	Do Nothing	Optional
Delimiter + 1		
Delimiter + 2		
Strip Delimiter		

[Delimiter + 1] or [Delimiter + 2]: The data will be transmitted when an additional byte (for Delimiter + 1), or an additional 2 bytes (for Delimiter + 2) of data is received after receiving the Delimiter.

[Strip Delimiter]: When the Delimiter is received, the Delimiter is deleted (i.e., stripped), and the remaining data is transmitted.

[Do nothing]: The data will be transmitted when the Delimiter is received.

Force transmit

Setting	Factory Default	Necessity
0 to 65535 ms	0 ms	Required

0: Disable the force transmit timeout.

1 to 65535: Forces the NPort 5200's TCP/IP protocol software to try to pack serial data received during the specified time into the same data frame.

This parameter defines the time interval during which NPort 5200 fetches the serial data from its internal buffer. If data is incoming through the serial port, NPort 5200 stores the data in the internal buffer. NPort 5200 transmits data stored in the buffer via TCP/IP, but only if the internal buffer is full or if the Force transmit time interval reaches the time specified under Force transmit timeout.

The optimal Force transmit timeout depends on your application, but it must be at least larger than one character interval within the specified baud rate. For example, assume that the serial port is set to 1200 bps, 8 data bits, 1 stop bit, and no parity. In this case, the total number of bits needed to send a character is 10 bits, and the time required to transfer one character is

$$(10 \text{ (bits)} / 1200 \text{ (bits/s)}) * 1000 \text{ (ms/s)} = 8.3 \text{ ms.}$$

Therefore, you should set Force transmit timeout to be larger than 8.3 ms, so in this case, it must be greater than or equal to 10 ms.

If the user wants to send a series of characters in the same packet, the serial device attached to NPort 5200 should send that series of characters during a time interval less than the Force transmit timeout for NPort 5200, and the total length of data must be less than or equal to NPort 5200's internal buffer size. The serial communication buffer size for NPort 5200 is 1 KB per port.

Destination IP address 1

Setting	Factory Default	Necessity
IP address range E.g., Begin: 192.168.1.1 End: 192.168.1.10	Begin: <i>blank</i>	Optional
	End: <i>blank</i>	
	Port: 4001	Required

Destination IP address 2/3/4

Setting	Factory Default	Necessity
IP address range E.g., Begin: 192.168.1.11 End: 192.168.1.20	Begin: <i>blank</i>	Optional
	End: <i>blank</i>	
	Port: 4001	Required

Local listen port

Setting	Factory Default	Necessity
1 to 65535	4001	Required

The UDP port that NPort 5200 listens to, and that other devices must use to contact NPort 5200. To avoid conflicts with common UDP ports, the default is set to 4001.

Pair Connection Mode

Pair Connection Mode employs two NPort 5200 device servers in tandem, and can be used to remove the 15-meter distance limitation imposed by the RS-232 interface. One NPort 5200 is connected from its RS-232 port to the COM port of a PC or other type of computer, such as hand-held PDAs that have a serial port, and the serial device is connected to the RS-232 port of the other NPort 5200. The two NPort 5200 device servers are then connected to each other with a cross-over Ethernet cable, both are connected to the same LAN, or in a more advanced setup, they communicate with each other over a WAN (i.e., through one or more routers). Pair Connection Mode transparently transfers both data and modem control signals (although it cannot transmit the DCD signal) between the two NPorts.

Pair Connection Master Mode

When using Pair Connection Mode, you must select **Pair Connection Master Mode** for the Operation mode of one of the NPort 5200 device servers. In effect, this NPort 5200 will be acting as a TCP client.

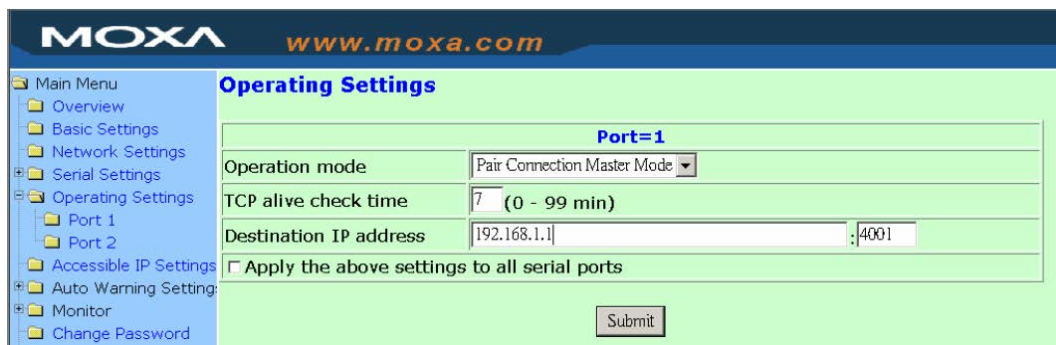

TCP alive check time

Setting	Factory Default	Necessity
0 to 99 min	7 min	Required

0 min: TCP connection is not closed due to an idle TCP connection.

1 to 99 min: The NPort 5200 closes the TCP connection automatically if there is no TCP activity for the given time.

Destination IP address

Setting	Factory Default	Necessity
IP address or Domain Name (E.g., 192.168.1.1)	blank	Optional
TCP port No.	4001	Required

The Pair Connection "Master" will contact the network host that has this IP address. Data will be transmitted through the port No. (4001 by default). Note that you must configure the same TCP port No. for the device server acting as the Pair Connection "Slave."

Pair Connection Slave Mode

When using Pair Connection Mode, you must select **Pair Connection Slave Mode** for the Operation mode of one of the NPort 5200 device servers. In effect, this NPort 5200 will be acting as a TCP server.

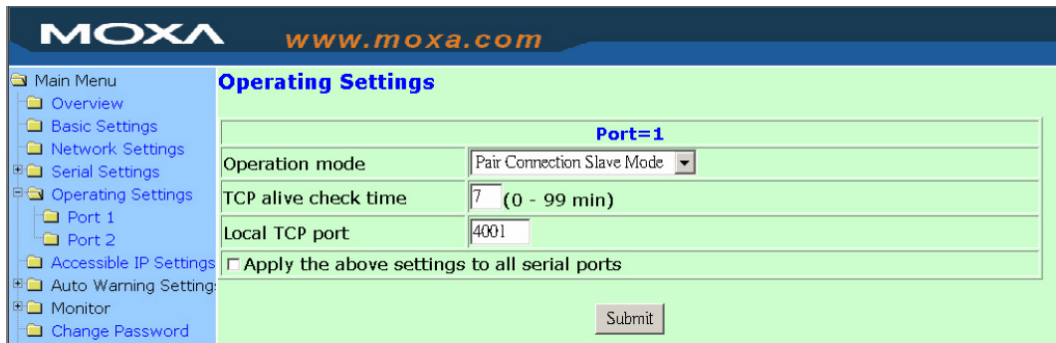

TCP alive check time

Setting	Factory Default	Necessity
0 to 99 min	7 min	Required

0 min: TCP connection is not closed due to an idle TCP connection.

1 to 99 min: The NPort 5200 closes the TCP connection automatically if there is no TCP activity for the given time.

Local TCP port

Setting	Factory Default	Necessity
TCP port No. (e.g., 4001)	4001	Required

This Port No. must be the same port No. that you set up for the Pair Connection “Master” device server.

Reverse Telnet Mode

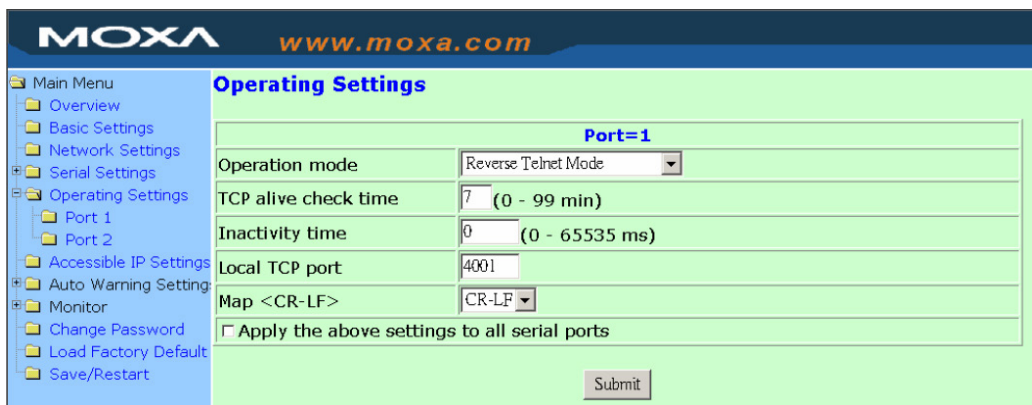

TCP alive check time

Setting	Factory Default	Necessity
0 to 99 min	7	Required

0 min: TCP connection is not closed due to an idle TCP connection.

1 to 99 min: NPort 5200 closes the TCP connection automatically if there is no TCP activity for the given time.

Inactivity time

Setting	Factory Default	Necessity
0 to 65535 ms	0	Required

Idle time setting for auto-disconnection. 0 min. means it will never disconnect.

Local TCP port

Setting	Factory Default	Necessity
1 to 65535	4001	Required

Each of NPort 5200's serial ports is mapped to a TCP port. To avoid conflicts with common TCP port numbers, set port numbers to 4001 for port 1, 4002 for port 2, etc.

Map <CR-LF>

Setting	Factory Default	Necessity
CR, LF, CR-LF	CR-LF	Required

If data received through NPort 5200's Ethernet port is sent using the "enter" command, the data will be transmitted out the serial port with an added

1. "carriage return + line feed" if you select the <CR-LF> option
(i.e., the cursor will jump to the next line, and return to the first character of the line)
2. "carriage return" if you select the <CR> option
(i.e., the cursor will return to the first character of the line)
3. "line feed" if you select the <LF> option.
(i.e., the cursor will jump to the next line, but not move horizontally)

Disabled Mode

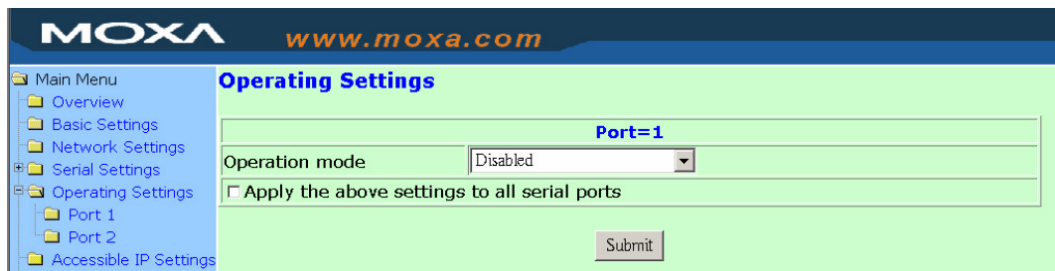

When Operation mode is set to Disabled, that particular port will be disabled. Check the "Apply the above settings to all serial ports" to apply this setting to the other port.

Accessible IP Settings

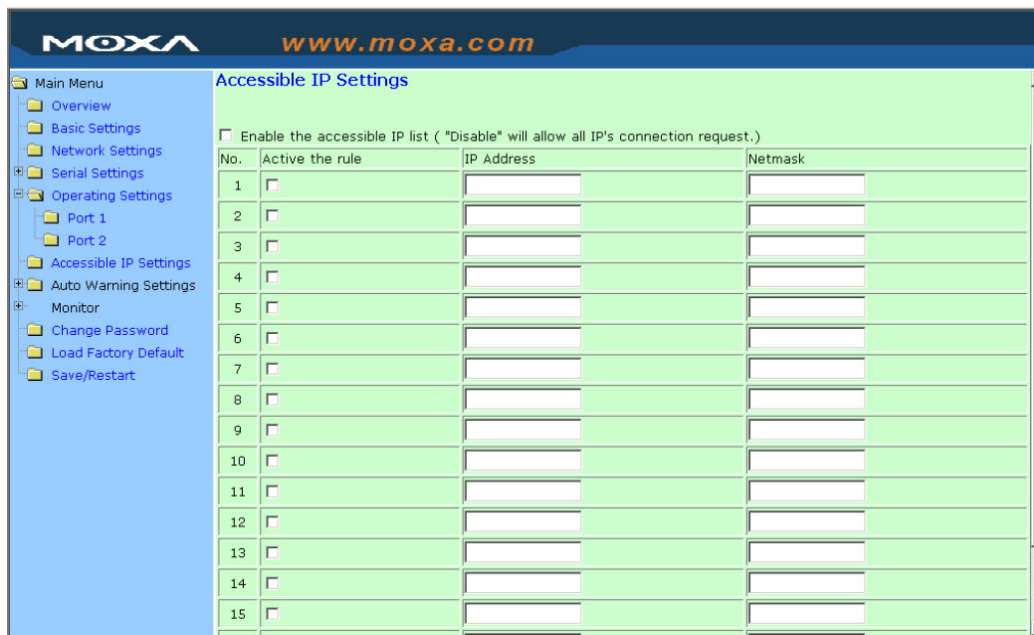

The NPort 5200 uses an IP address based filtering method to control access to itself.

Accessible IP Settings allows you to add or block remote host IP addresses to prevent unauthorized access. Access to NPort 5200 is controlled by IP address. That is, if a host's IP address is in the accessible IP table, then the host will be allowed to access the NPort 5200. You can use one of the following types of access.

- **Only one host with a specified IP address can access the NPort 5200**
Use Netmask = 255.255.255.255 for one of the Accessible IP Settings rules.
- **Hosts on a specific subnet can access the NPort 5200**
Use a non-trivial Netmask, such as 255.255.255.0, for one of the Accessible IP Settings rules.
- **Any host can access the NPort 5200**
Disable this function by un-checking the "Enable the accessible IP list" checkbox.

The following table shows six specific Accessible IP Settings rules. In the "Input format" column, "192.168.1.123 / 255.255.255.255" means you should enter 192.168.1.123 for IP Address, and 255.255.255.255 for Netmask.

Allowable Hosts	Input Format
Any host	Disable
192.168.1.120	192.168.1.120 / 255.255.255.255
192.168.1.1 to 192.168.1.254	192.168.1.0 / 255.255.255.0
192.168.0.1 to 192.168.255.254	192.168.0.0 / 255.255.0.0
192.168.1.1 to 192.168.1.126	192.168.1.0 / 255.255.255.128
192.168.1.129 to 192.168.1.254	192.168.1.128 / 255.255.255.128

Auto Warning Settings

Auto warning: Email and SNMP trap

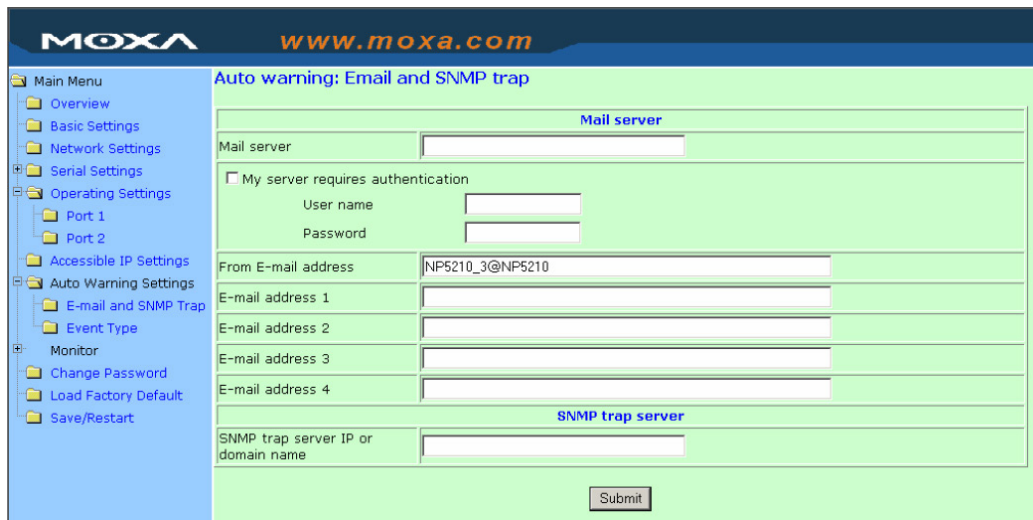

Mail Server

Mail server

Setting	Factory Default	Necessity
IP Address or Domain Name	blank	Optional

User name

Setting	Factory Default	Necessity
1 to 15 characters	blank	Optional

Password

Setting	Factory Default	Necessity
1 to 15 characters	blank	Optional

From E-mail address

Setting	Factory Default	Necessity
1 to 63 characters	blank	Optional

E-mail address 1/2/3/4

Setting	Factory Default	Necessity
1 to 63 characters	blank	Optional



ATTENTION

Consult your Network Administrator or ISP for the proper mail server settings. The Auto warning function may not work properly if it is not configured correctly. NPort 5200 SMTP AUTH supports LOGIN, PLAIN, CRAM-MD5 (RFC 2554).

SNMP Trap Server

SNMP trap server IP or domain name

Setting	Factory Default	Necessity
IP address or Domain Name	blank	Optional

Event Type

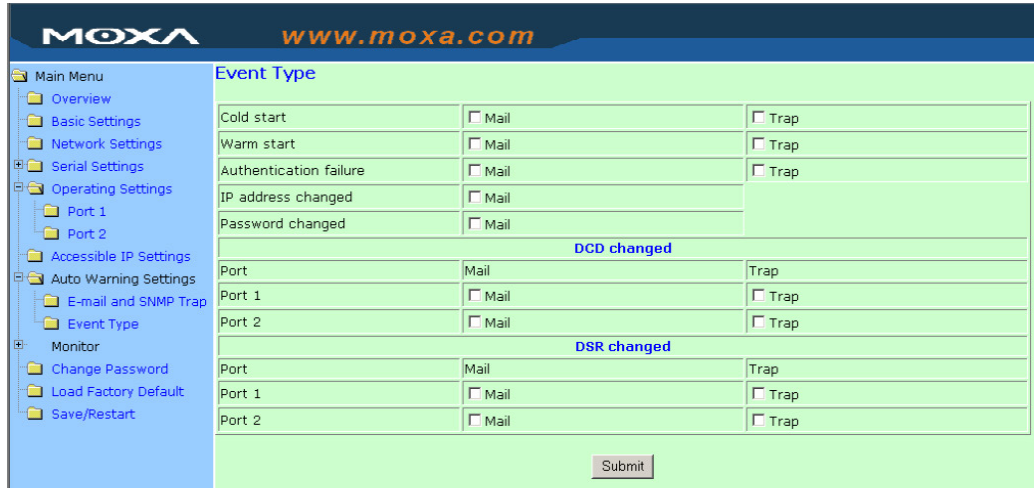

Cold start

This refers to starting the system from power off (contrast this with warm start). When performing a cold start, NPort 5200 will issue an Auto warning message automatically by e-mail, or send an SNMP trap after booting up.

Warm start

This refers to restarting the computer without turning the power off. When performing a warm start, NPort 5200 will send an e-mail automatically, or send an SNMP trap after rebooting.

Authentication failure

Authentication failure occurs when the user inputs a wrong password from the Console or Administrator. When authentication failure occurs, the NPort 5200 will immediately send an e-mail or SNMP trap.

IP address changed

The user has changed NPort 5200's IP address. When the IP address changes, NPort 5200 will send an e-mail with the new IP address before NPort 5200 reboots. If the NPort 5200 is unable to send an e-mail message to the mail server within 15 seconds, NPort 5200 will reboot anyway, and abort the e-mail auto warning.

Password changed

The user has changed NPort 5200's password. When the password changes, NPort 5200 will send an e-mail with the password changed notice before NPort 5200 reboots. If the NPort 5200 is unable to send an e-mail message to the mail server within 15 seconds, NPort 5200 will reboot anyway, and abort the e-mail auto warning.

DCD changed

The DCD (Data Carrier Detect) signal has changed, also indicating that the modem connection status has changed. For example, a DCD change to high also means "Connected" between local modem and remote modem. If the DCD signal changes to low, it also means that the connection line is down.

When the DCD changes, the NPort 5210/5230 will immediately send an e-mail or send an SNMP trap.

DSR changed

The DSR (Data Set Ready) signal has changed, also indicating that the data communication equipment's power is off. For example, a DSR change to high also means that the DCE is powered ON. If the DSR signal changes to low, it also means that the DCE is powered off.

When the DSR changes, the NPort 5210/5230 will immediately send an e-mail or send an SNMP trap.

Mail

Setting	Factory Default	Necessity
Enable, Disable	Disable	Optional

This feature helps the administrator manage how the NPort 5200 sends e-mail to pre-defined e-mail boxes when the enabled events—such as Cold start, Warm start, Authentication failure, etc.—occur. To configure this feature, click on the Event Type Mail checkbox.

Trap

Setting	Factory Default	Necessity
Enable, Disable	Disable	Optional

This feature helps the administrator manage how the NPort 5200 sends SNMP Trap to a pre-defined SNMP Trap server when the enabled events—such as Cold start, Warm start, Authentication failure, etc.—occur. To configure this feature, click on the Event Type Trap checkbox.



ATTENTION

DCD changed and **DSR changed** events are only supported by RS-232 ports (ports 1 and 2 for NPort 5210, and port 1 for NPort 5230). Since NPort 5232 and NPort 5232I do not have RS-232 ports, the **DCD changed** and **DSR changed** options will not appear in the **Event Type** screen.

Monitor

Monitor Line

Click on **Line** under **Monitor** to show the operation mode and status of each connection (IPx), for each of the two serial ports.

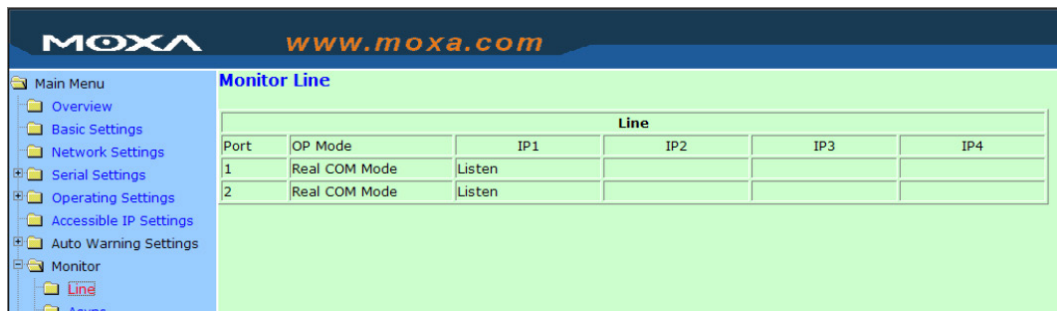

Monitor Async

Click on **Async** under **Monitor** to show the current status of each of the two serial ports.

Async							
Port	TxCnt	RxCnt	TxTotalCnt	RxTotalCnt	DSR	CTS	DCD
1	0	0	0	0	OFF	OFF	OFF
2	0	0	0	0	OFF	OFF	OFF

Monitor Async-Settings

Click on **Async Setting** under **Monitor** to show the run-time settings for each of the two serial ports.

Async-Settings								
Port	Baud rate	Data bits	Stop bits	Parity	FIFO	RTS/CTS	XON/XOFF	DTR/DSR
1	19200	8	1	None	Enable	OFF	OFF	OFF
2	115200	8	1	None	Enable	OFF	OFF	OFF

Change Password

Input the "Old password" and "New password" to change the password. Leave the password boxes blank to erase the password. Keep in mind that if the password is erased, then NPort 5200 will not have password protection.



ATTENTION

If you forget the password, the ONLY way to configure NPort 5200 is by using the Reset button on NPort 5200's casing to "Load Factory Default."

Remember to export the configuration file using NPort Administrator when you finish the configuration. By using the Import function of NPort Administrator, your configuration can be re-loaded into NPort 5200 after using "Load Factory Default." Refer to Chapter 6 for more details about the Export and Import function.

Load Factory Default

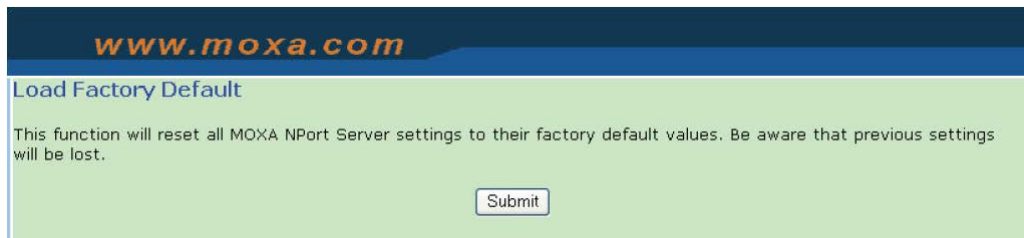

The screenshot shows a web console interface with a dark blue header containing the URL *www.moxa.com*. Below the header, the page title is "Load Factory Default". The main content area has a light green background and contains the text: "This function will reset all MOXA NPort Server settings to their factory default values. Be aware that previous settings will be lost." At the bottom center of this area is a "Submit" button.

Use this function to reset all of NPort 5200's settings to the factory default values. Be aware that previous settings will be lost.

Configuring NPort Administrator

The following topics are covered in this chapter:

- ❑ **Overview**
- ❑ **Installing NPort Administrator**
- ❑ **Configuration**
 - Broadcast Search
 - Unlock Password Protection
 - Configuring the NPort 5200
 - Upgrading the Firmware
 - Export Configuration
 - Import Configuration
- ❑ **Monitor**
- ❑ **Port Monitor**
- ❑ **COM Mapping**
 - On-line COM Mapping
 - Off-line COM Mapping
- ❑ **IP Address Report**

Overview

Device Server Administrator lets you install and configure your NPort 5200 Series products easily over the network. Five function groups are provided to ease the installation process, allow off-line COM mapping, and provide monitoring and IP location server functions.

Device Server Administrator is an integrated software suite that bundles Device Server Administrator and the IP Serial Library, and provides everything you need to manage, monitor, and modify your NPort 5200 from a remote location.

Installing NPort Administrator

1. Once the Setup program starts running, click on **Next** when the **Welcome** window opens to proceed with the installation.

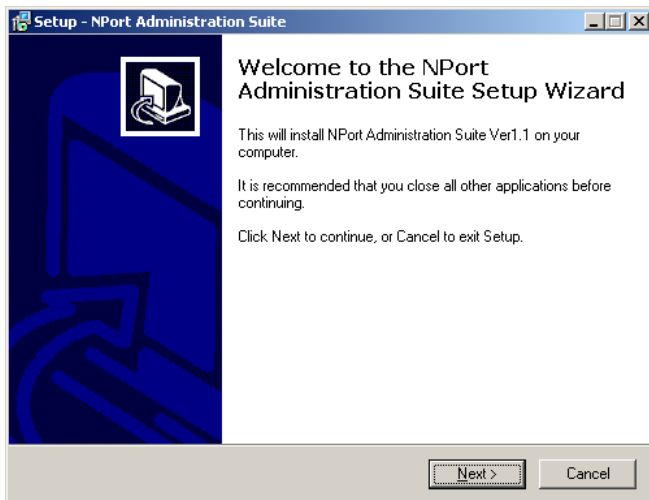

2. Click on **Next** to install program files in the default directory, or select an alternative location.

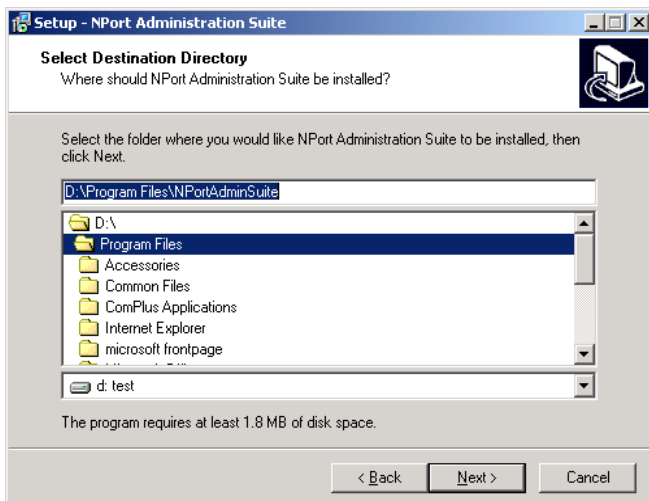

3. Click on **Next** to install the program using the default program name, or select a different name.

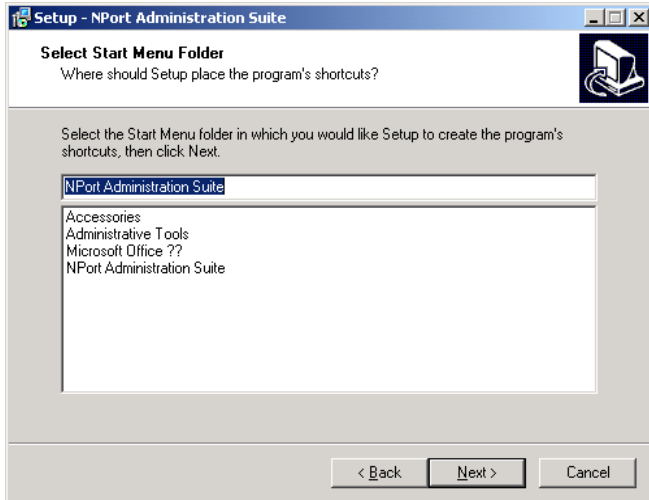

4. Click on **Install** to proceed with the installation.

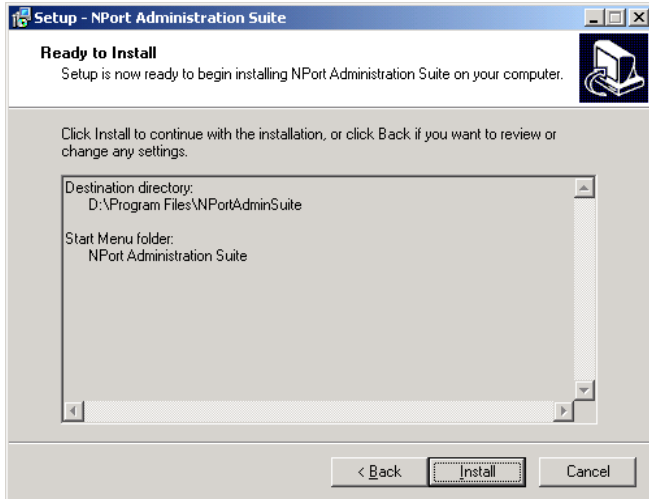

5. The **Installing** window reports the progress of the installation.

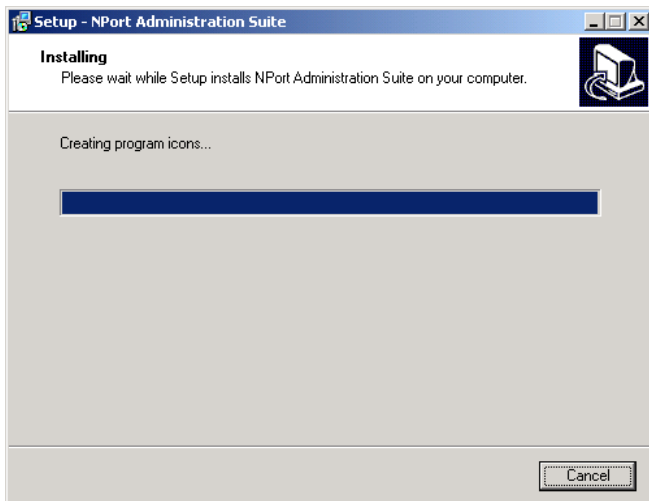

6. Click on **Next** to proceed with the installation.

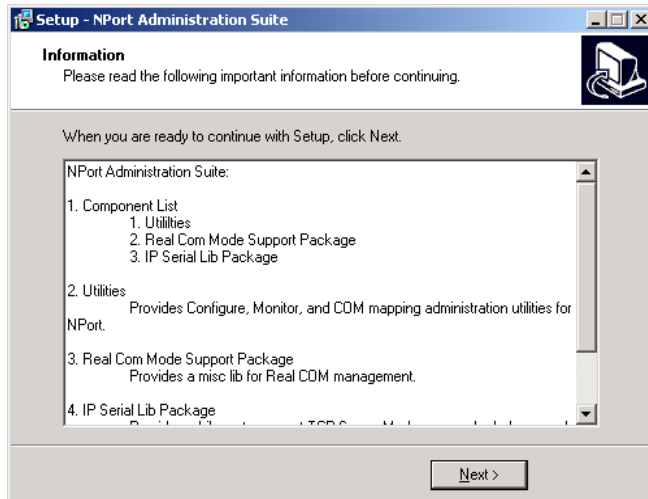

7. Click on **Finish** to complete the installation of NPort 5200 Administration Suite.

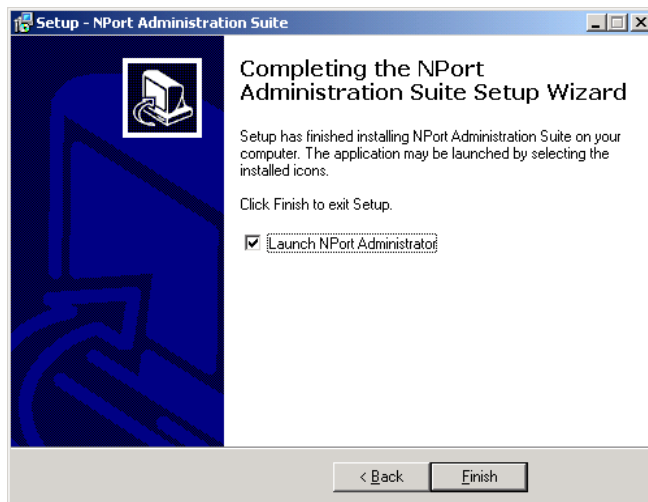

Configuration

The Administrator-Configuration window is divided into four parts.

- The top section contains the function list and online help area. (Windows NT does not support this .chm file format.)
- The five Administrator function groups are listed in the left section.
- A list of NPort 5200 serial device servers, each of which can be selected to process user requirements, is displayed in the right section.
- The activity Log, which displays messages that record the user's processing history, is shown in the bottom section.

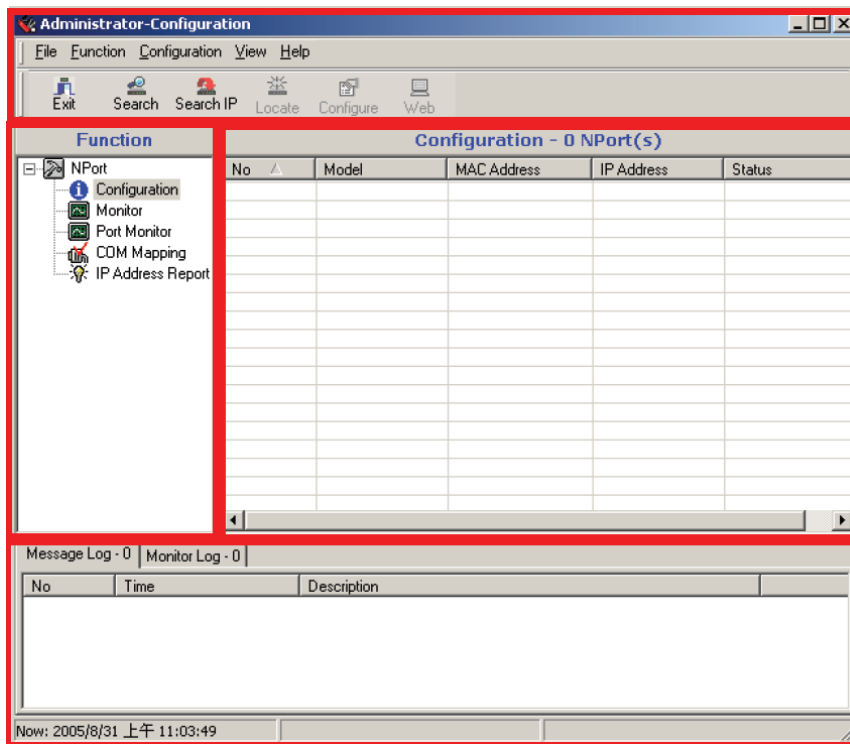

Broadcast Search

The **Broadcast Search** function is used to locate all NPort 5200s that are connected to the same LAN as your computer. Since the Broadcast Search function searches by MAC address and not IP address, all NPort 5200s connected to the LAN will be located, regardless of whether or not they are part of the same subnet as the host.

1. Position the cursor in the right middle section of the Administrator window and then click the right mouse button.

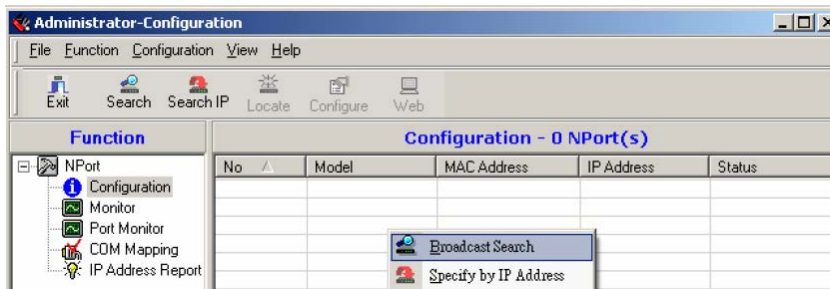

2. The **Broadcast Search** window will open and display the Model, IP Address, MAC Address, and Progress of the search for that particular device.

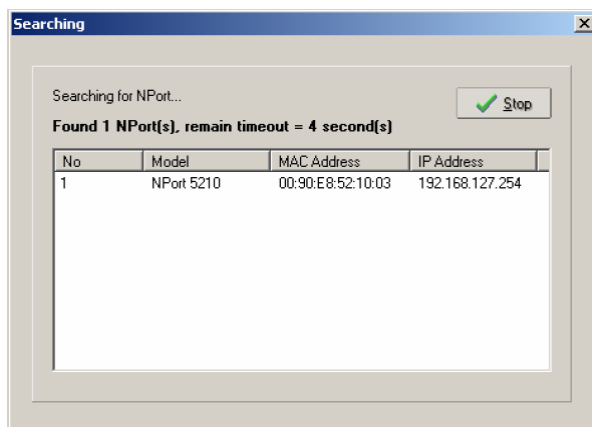

- When the search is complete, the Broadcast Search window will close, and the NPort 5200s that were located will be displayed in the right pane of the Administrator window. If you found more than one server connected to this network, refer to the MAC address sticker on your server(s) to determine which server(s) are the ones you wish to configure. To configure an NPort 5200, place the cursor over the row displaying that NPort 5200's information, and then double click the left mouse button.

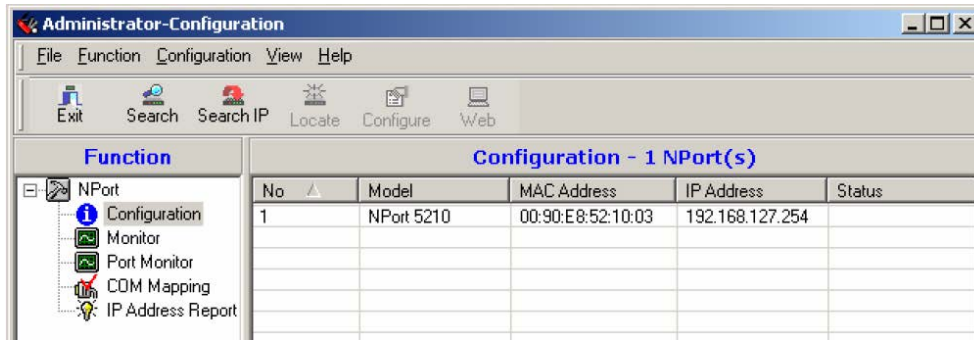

ATTENTION

Before modifying the NPort 5200's configuration, use Broadcast Search to locate all NPort 5200s connected to the LAN, or use Specify by IP Address to locate a particular NPort 5200.

Unlock Password Protection

If the NPort 5200 is password protected (indicated by "Lock" for Status), you will receive the following error, and you will not be able to use the right click method to open the configuration page.

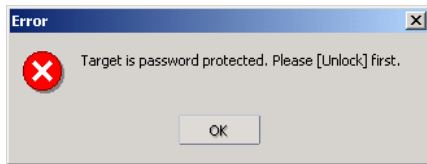

In this case, proceed as follows to "Unlock" the device server.

- Select the NPort 5200 with "Lock" status, click the right mouse button, and then select **Unlock**.

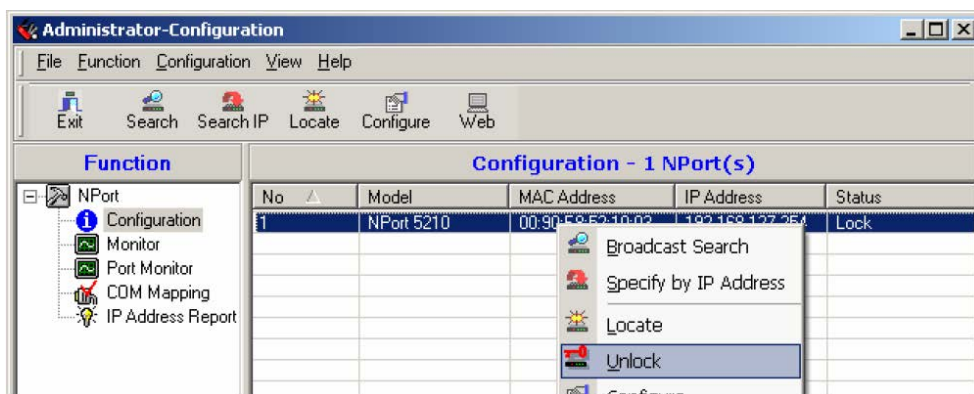

- Input the password and then click on **OK**.

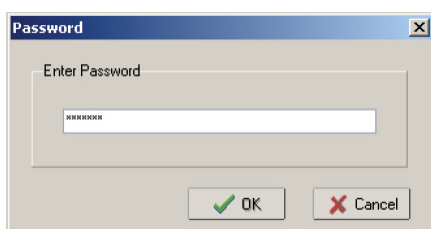

- The NPort Administrator will display an "Unlock ok" message.



- The "Lock" status will change to "Unlock," and the Administrator utility will keep this NPort 5200 in the Unlock status throughout this Administrator session.

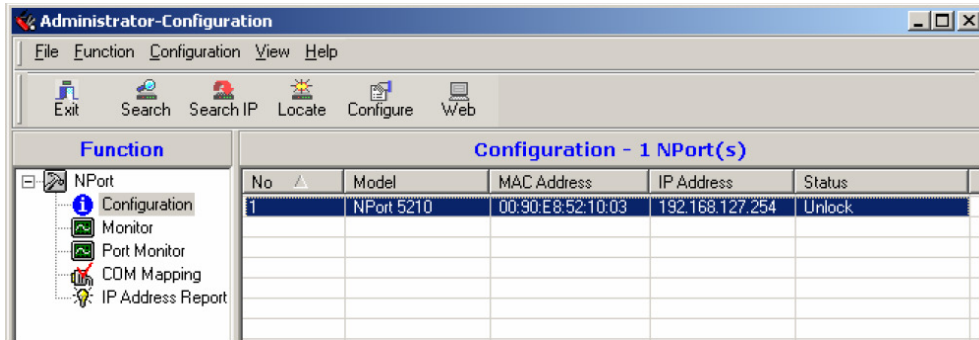

The meanings of the six "Status" states are given below (note that the term Fixed is borrowed from the standard fixed IP address networking terminology):

Lock

The NPort 5200 is password protected, "Broadcast Search" was used to locate it, and the password has not yet been entered from within the current Administrator session.

Unlock

The NPort 5200 is password protected, "Broadcast Search" was used to locate it, and the password has been entered from within the current Administrator session. Henceforth during this Administrator session, activating various utilities for this NPort 5200 will not require re-entering the server password.

Blank

The NPort 5200 is not password protected, and "Broadcast Search" was used to locate it.

Fixed

The NPort 5200 is not password protected, and "Search by IP address" was used to locate it.

Lock Fixed

The NPort 5200 is password protected, "Specify by IP address" was used to locate it, and the password has not yet been entered from within the current Administrator session.

Unlock Fixed

The NPort 5200 is password protected, "Specify by IP address" was used to locate it, and the password has been entered from within the current Administrator session. Henceforth during this Administrator session, activating various utilities for this NPort 5200 will not require re-entering the server password.

Configuring the NPort 5200

In this section, we illustrate how to access the NPort 5200's configuration utility. You should first make sure that you can connect over the network from your computer to the NPort 5200.

- To start NPort Administrator, click on **Start → NPort Administration Suite → NPort Administrator**.

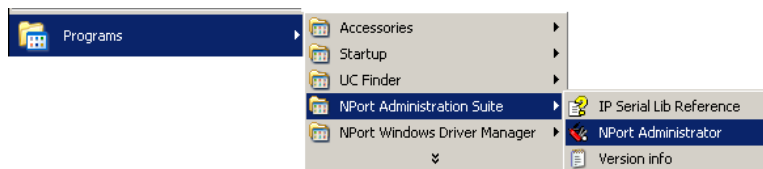

2. Unlock the NPort 5200 you wish to configure if it is password protected. Right click on the NPort 5200 and select **Configure** to start the configuration.

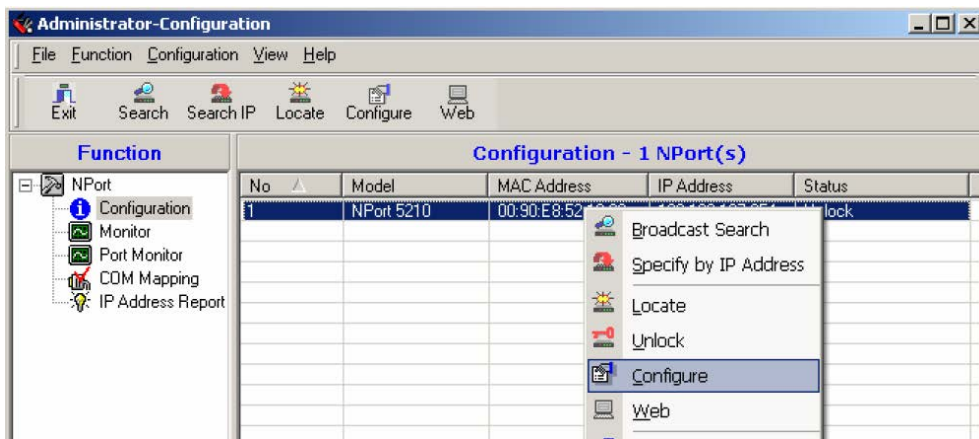

3. The progress bar shows that Administrator is retrieving configuration information from the specific NPort 5200.

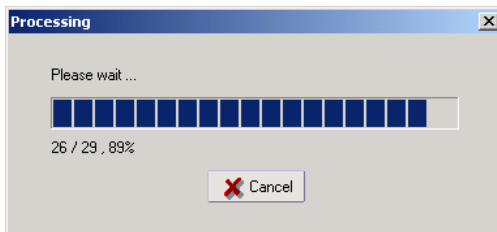

4. Refer to Chapter 5 for each parameter's function definition. To modify the configuration, you must first click in the modify box to activate the parameter setting box. For example, click on the middle modify box.

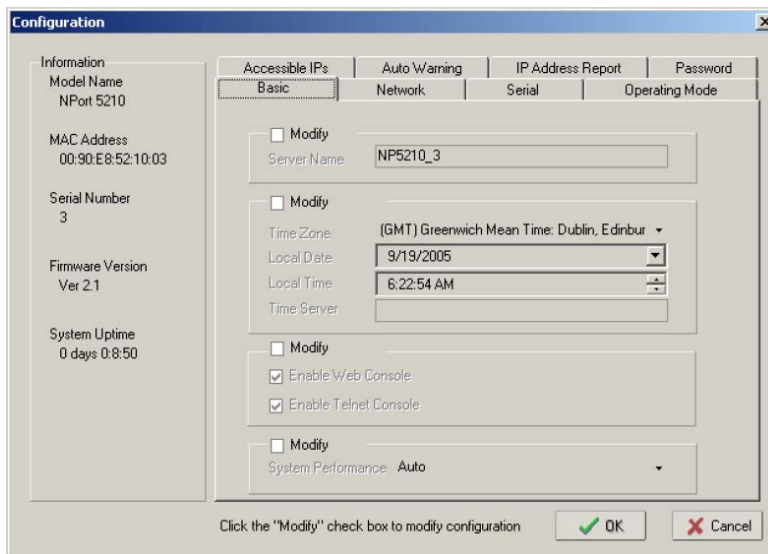

- You will now be able to modify **Time Zone**, **Local Date**, **Local Time**, and **Time Server**.

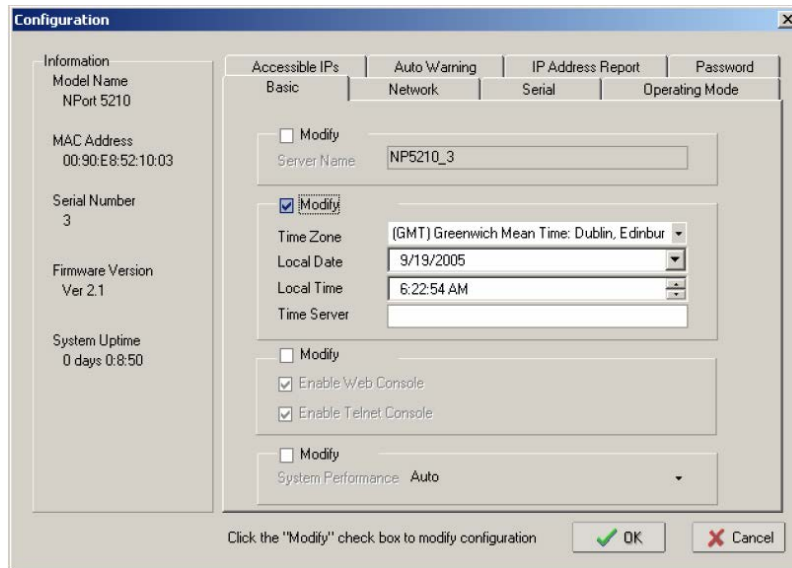

ATTENTION

You can simultaneously modify the configurations of multiple NPort 5200s that are of the same model. To select multiple NPort 5200s, hold down the Ctrl key when selecting additional NPort 5200s, or hold down the Shift key to select a group of NPort 5200s.

Upgrading the Firmware

Follow these steps to upgrade the firmware of an NPort 5200.

- To start NPort Administrator, click on **Start → NPort Administration Suite → NPort Administrator**.

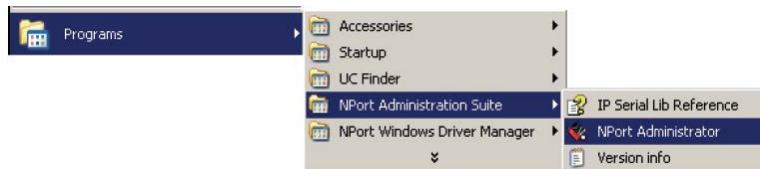

- Unlock the NPort 5200 you wish to configure if it is password protected. Right click on a specific NPort 5200 and select the **Upgrade Firmware** function to start upgrading the firmware.

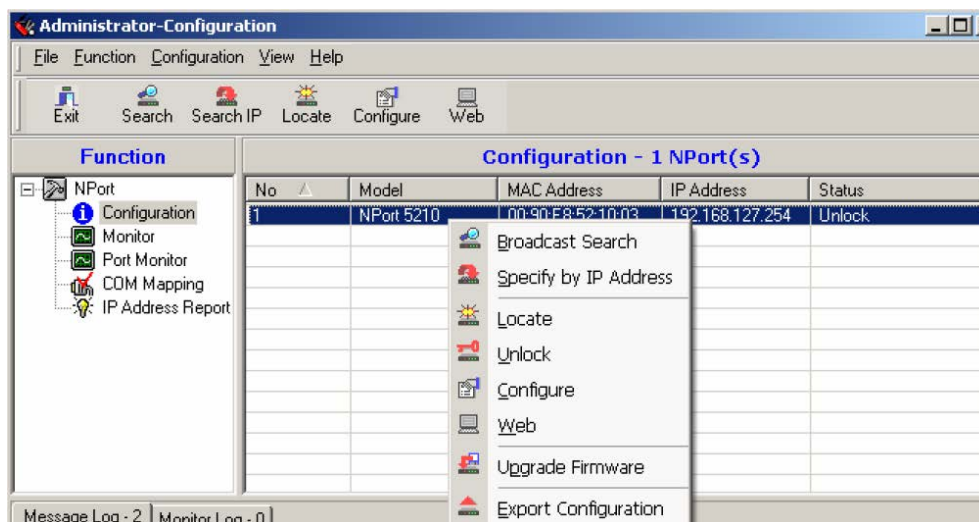

3. Select the correct ROM file to download.

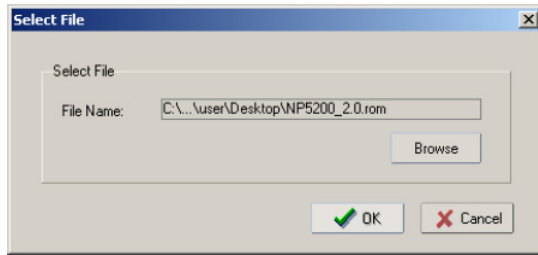

4. Wait while the Upgrade Firmware action is processed.

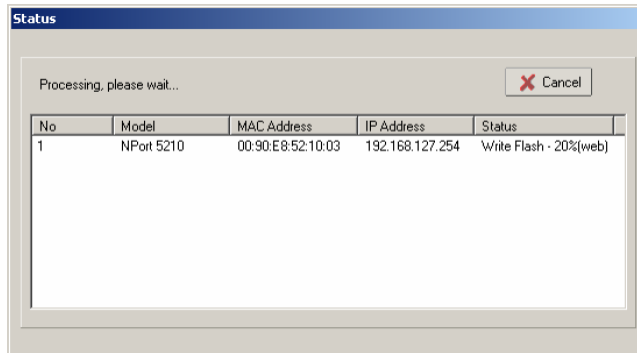

ATTENTION

You can simultaneously upgrade the firmware of multiple NPort 5200s that are of the same model. To select multiple NPort 5200s, hold down the Ctrl key when selecting an additional NPort 5200, or hold down the Shift key to select a block of NPort 5200s.

Export Configuration

To export the configuration of an NPort 5200, right click on the NPort 5200, select Export Configuration, and then follow the onscreen instructions. The Export Configuration function is a handy tool that can be used to produce a text file containing the current configuration of a particular NPort 5200.

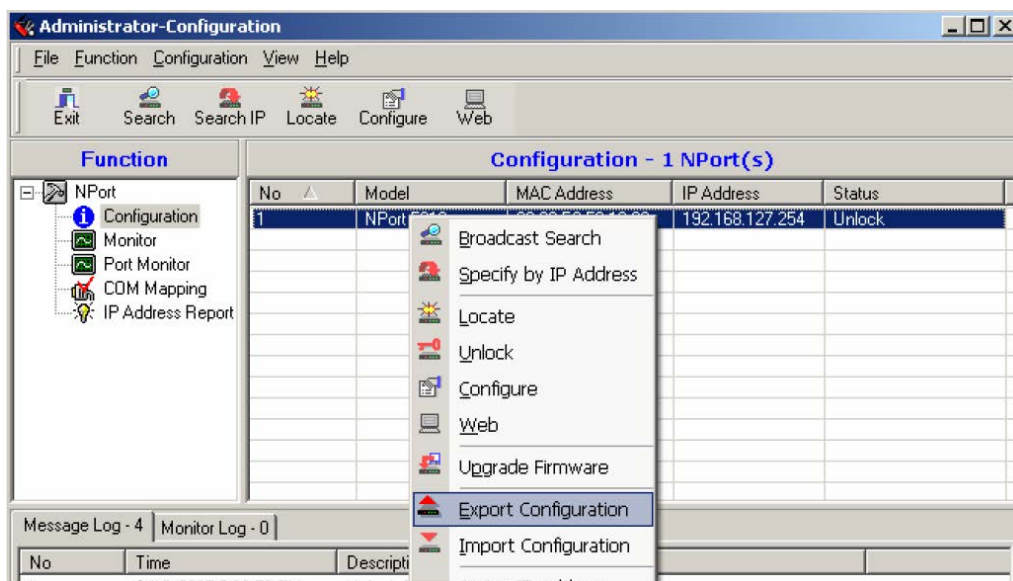

Import Configuration

The Import Configuration function is used to import an NPort 5200 configuration from a file into one or more of the same model NPort 5200. To import a configuration, first select the target servers, click the right mouse button, and then select Import Configuration. Follow the onscreen instructions to locate the configuration file and start downloading the file.

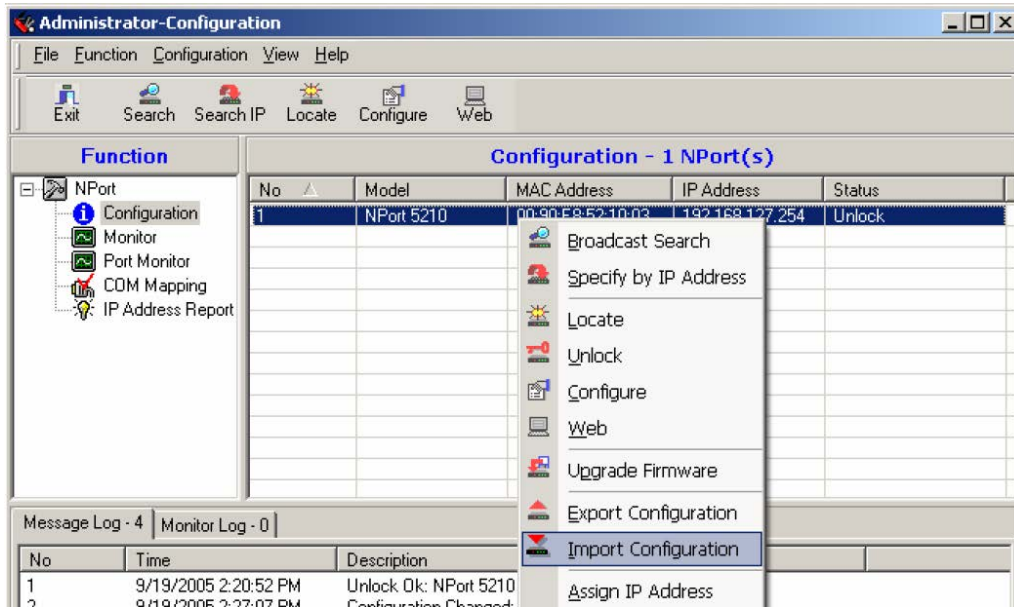

ATTENTION

You can simultaneously import the same configuration file into multiple NPort 5200s that are of the same model.

To select multiple NPort 5200s, hold down the Ctrl key when selecting an additional NPort 5200, or hold down the Shift key to select a block of NPort 5200s.

Monitor

Use one of the following two methods to start the Monitor function.

Broadcast Search → Monitor → Add Target

1. With **Configuration** selected under **Function**, use **Broadcast Search** to locate all NPorts on your LAN.

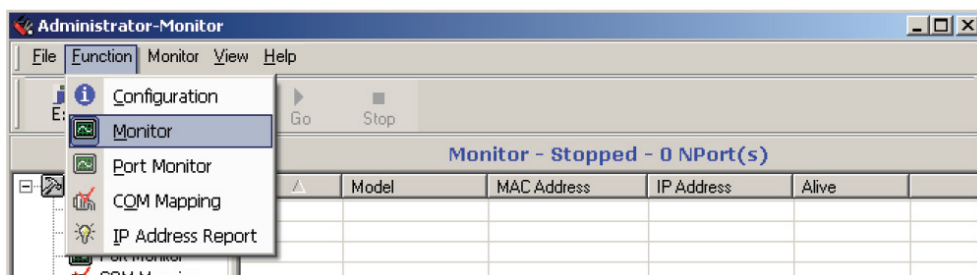

- Next, click on **Monitor → Add Target**, select your targets from the list, and then click on **OK**.

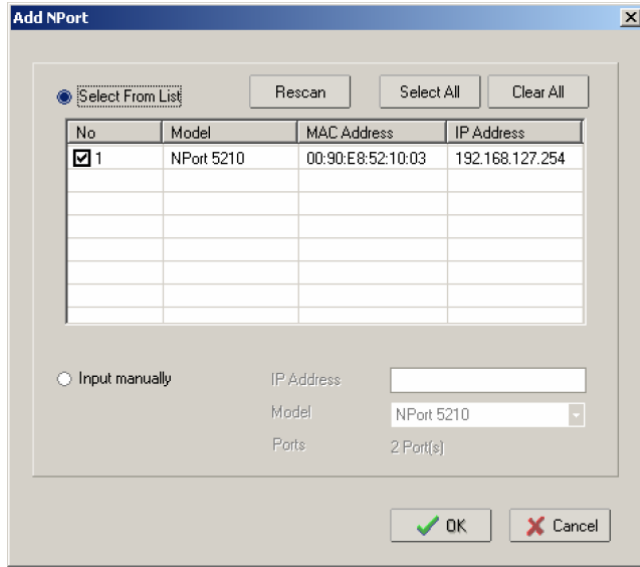

Monitor → Add Target → Rescan

- Click on **Monitor** under **Function**.

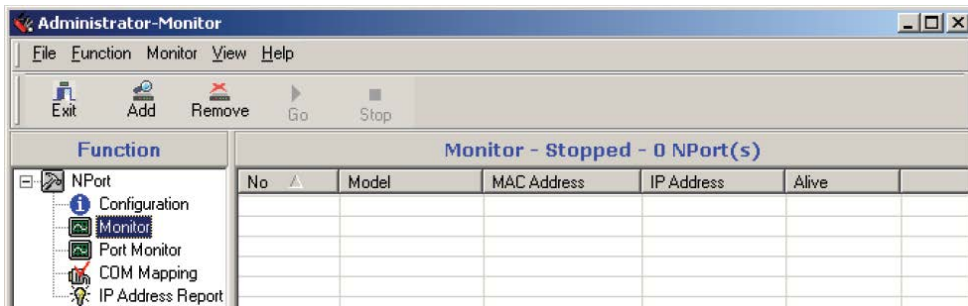

- Click on **Monitor → Add Target** from the menu bar, or click the right mouse button and select **Add Target**.

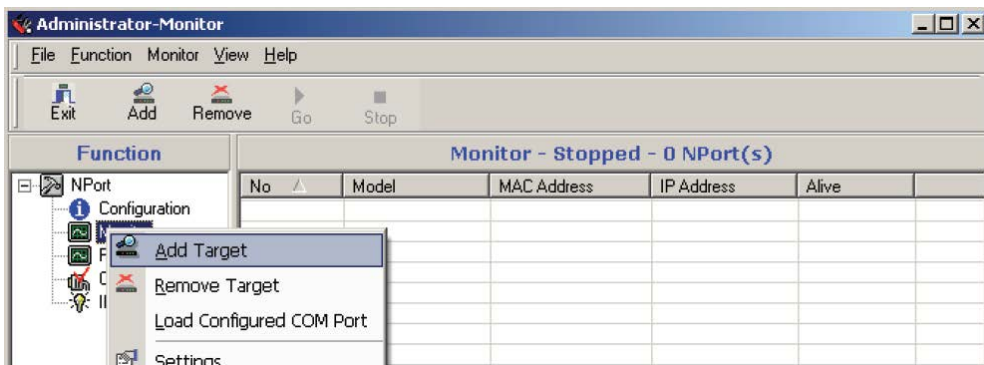

3. Click on **Rescan**.

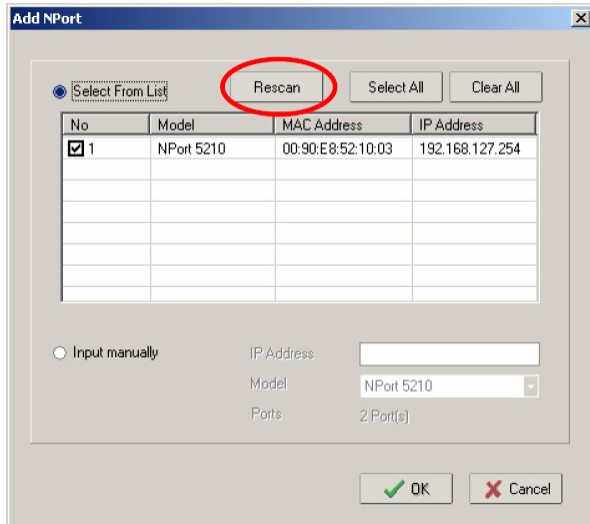

4. Select your targets from the list, and then click on **OK**.

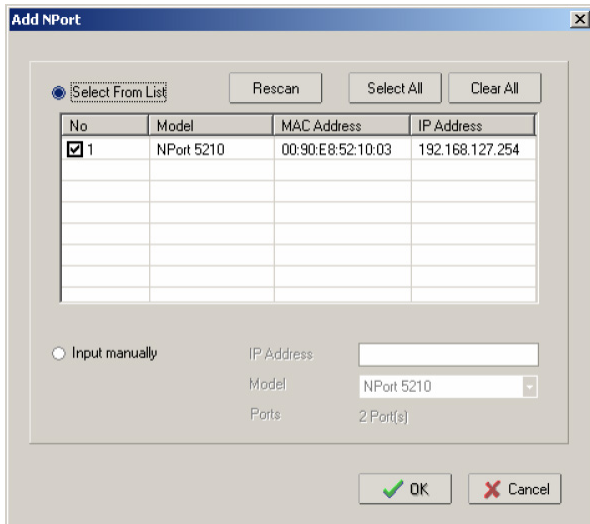

Once the Monitor function is running:

1. The NPort 5200 list will appear on the Monitor screen.

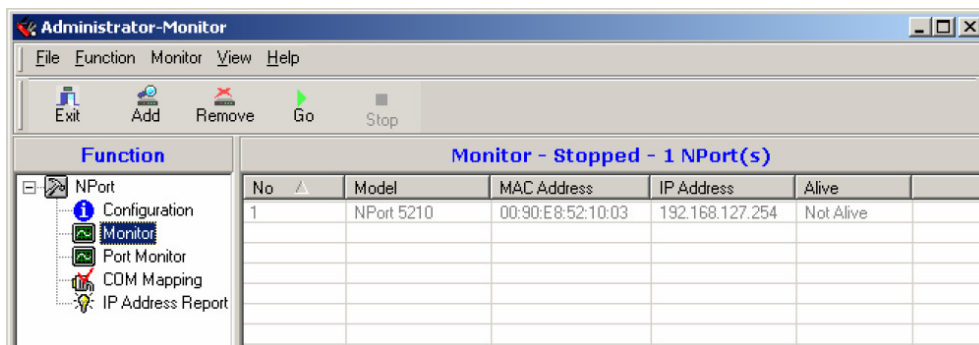

2. Right click the panel and select **Settings**.

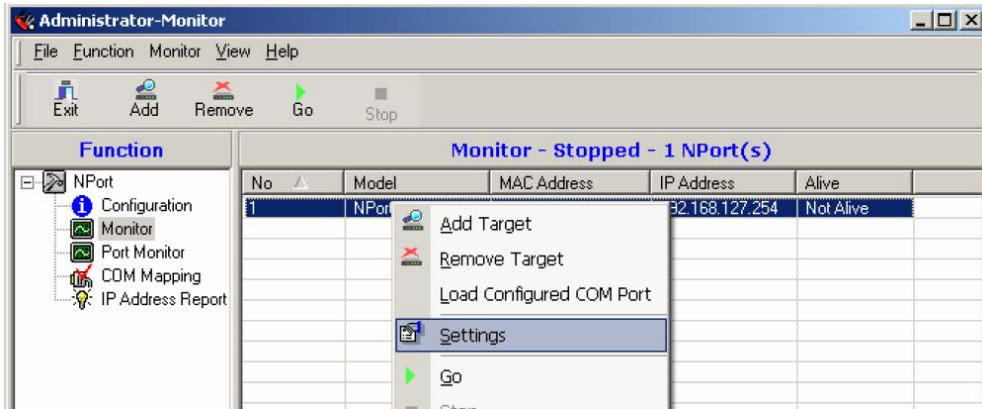

3. Select or de-select **Monitor Items**. Use the single arrowhead buttons to move highlighted items from one box to the other. Use the double arrowhead buttons to move all items in one box to the other.

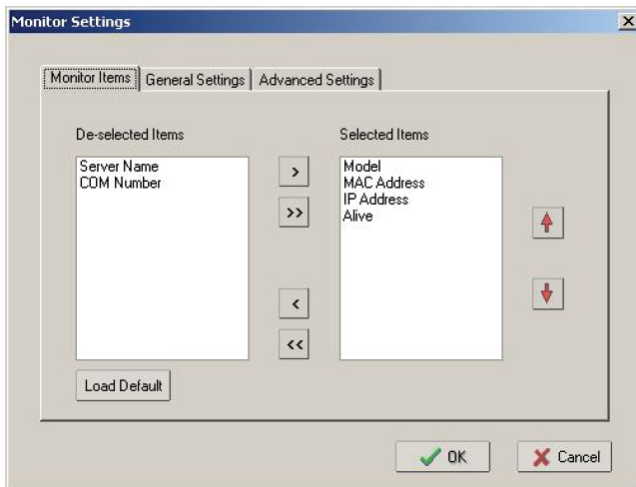

4. Select a **Refresh Rate** (the default is 3 seconds) on the General Settings page.

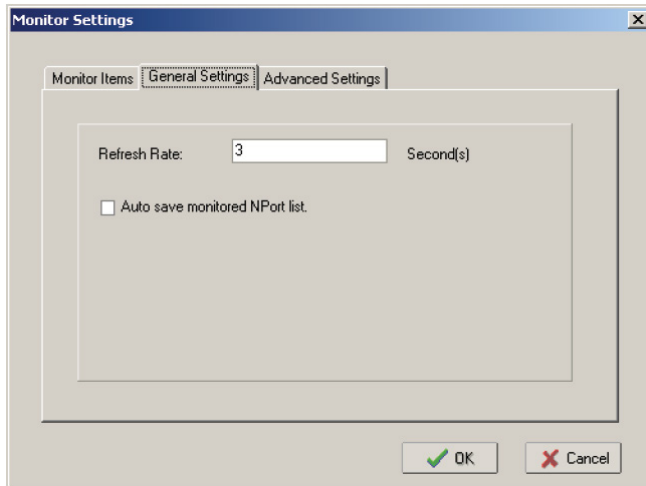

- On the **Advanced Settings** page, select **Display warning message for new event** and/or **Play warning music for new event**. In the second case, you must enter the path to the WAV file that you want to be played. "New event" means that one of the NPort 5200s in the monitor is "Alive" or "Not Alive," or has lost connection with the Monitor program.

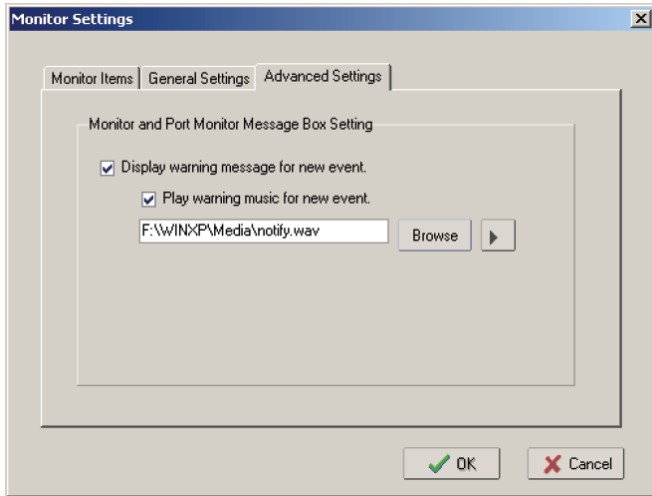

- Right click in the NPort 5200 list section and select **Go** to start Monitoring the NPort 5200.

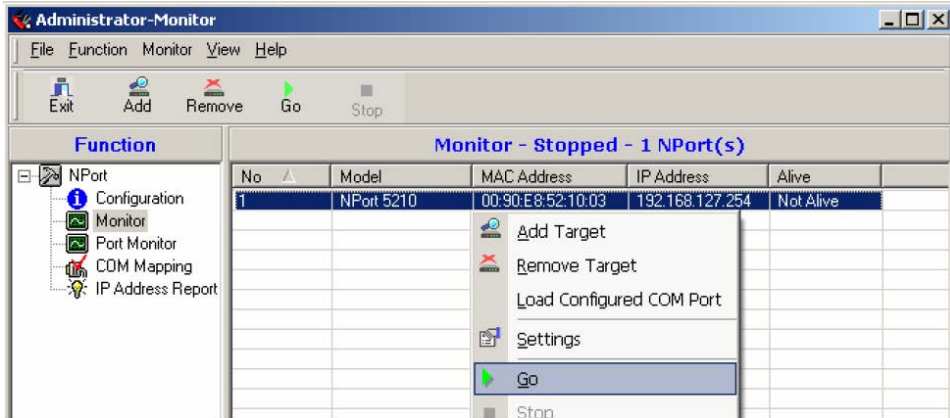

- For this example, the NPort 5200s shown in the list will be monitored.

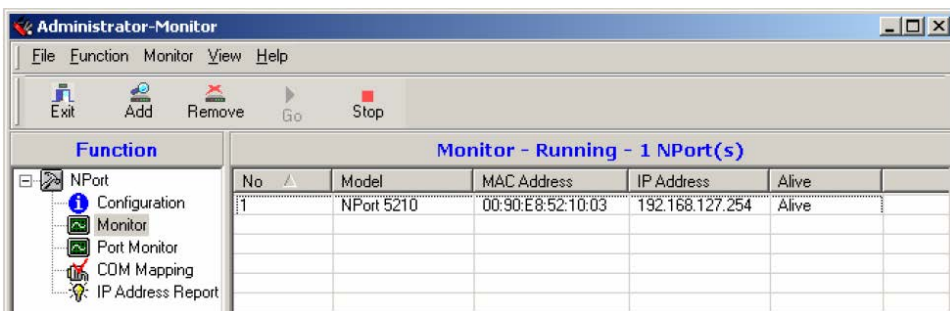

- When one of the NPort 5200s loses connection with the Monitor program, a warning alert will display automatically. The warning music will be played at the same time.

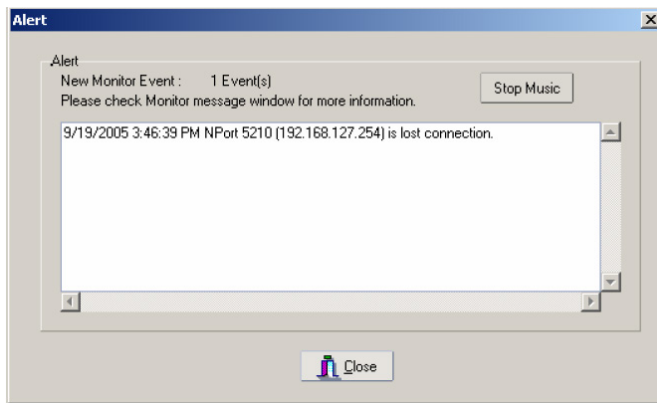

- In the Monitor screen, you can see that the NPort 5200s that are "Not Alive" are shown in red color.

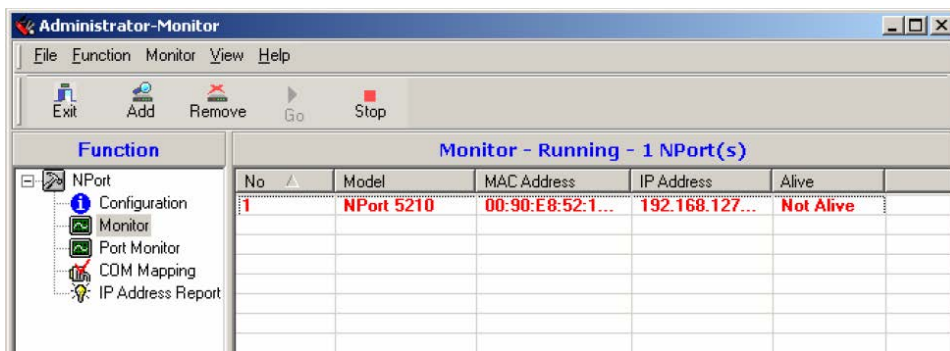

- If the NPort 5200 gets reconnected, a warning will be displayed to remind the user that the NPort 5200 is now "Alive."

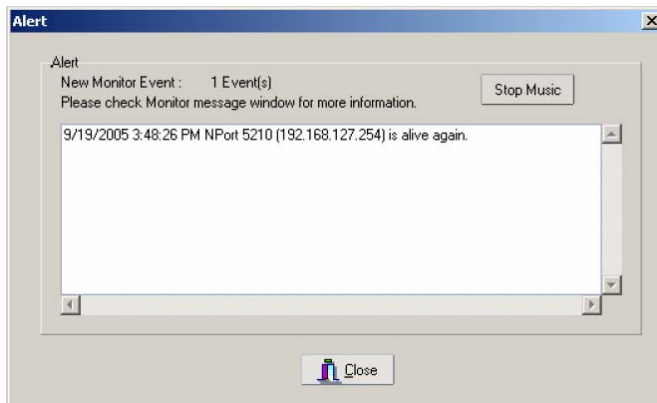

- The NPort 5200s that were reconnected, and are now "Alive," will be shown in black color.

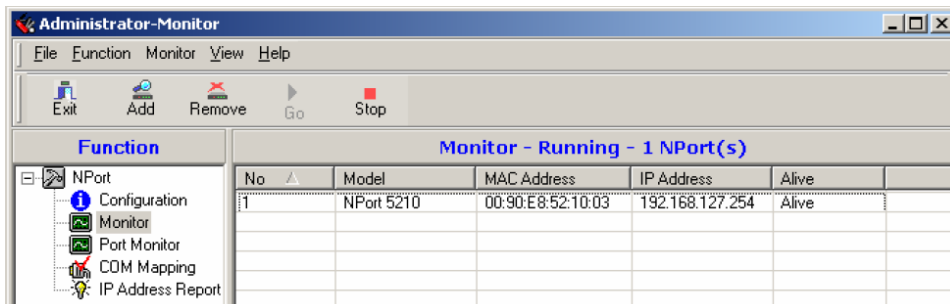

Port Monitor

The process described here is the same as in the previous "Monitor" section. The only difference is that you can select more items under Port Monitor than under Monitor.

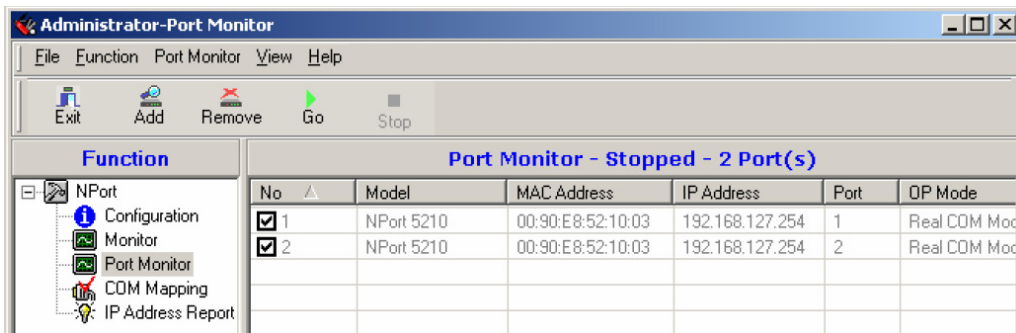

Select or de-select **Monitor Items**. Use the single arrowhead buttons to move highlighted items from one box to the other. Use the double arrowhead buttons to move all items in one box to the other.

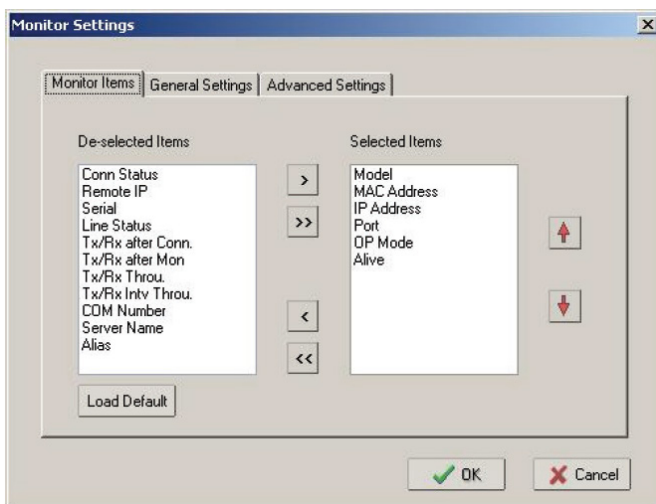

COM Mapping

Windows Administration Suite comes with Windows Real COM drivers. After you install NPort 5200 Administration Suite, there are two ways to set up the NPort 5200 serial port as your host's remote COM port.

The first way is with **On-line COM Mapping**. On-line COM Mapping will check to make sure that the NPort 5200 is connected correctly to the network, and then install the driver on the host computer.

The second way is with **Off-line COM Installation**, without first connecting the NPort 5200 to the network. Off-line COM Mapping can decrease the system integrator's effort by solving different field problems. Via off-line installation, users can first process software installation for the host, and then install the NPort 5200 to different fields.

Use the following procedure to map COM ports:

1. On-line COM Mapping:
 Connect NPort 5200 to the network → Set NPort 5200 to the proper IP address → Map COMs to your host → Apply Change.
2. Off-line COM Mapping:
 Map COMs to your host → Apply Change → Connect the NPort 5200 to the network → Configure the NPort 5200's IP address.

On-line COM Mapping

1. **Broadcast Search** for NPort 5200s on the network.

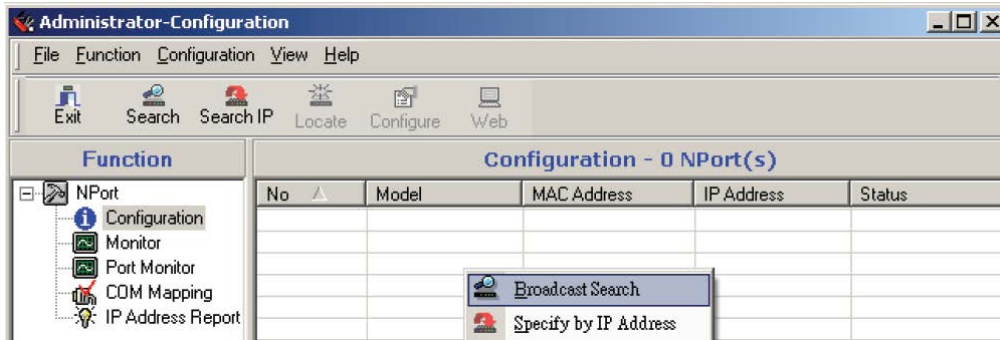

2. Select the **COM Mapping** function group.

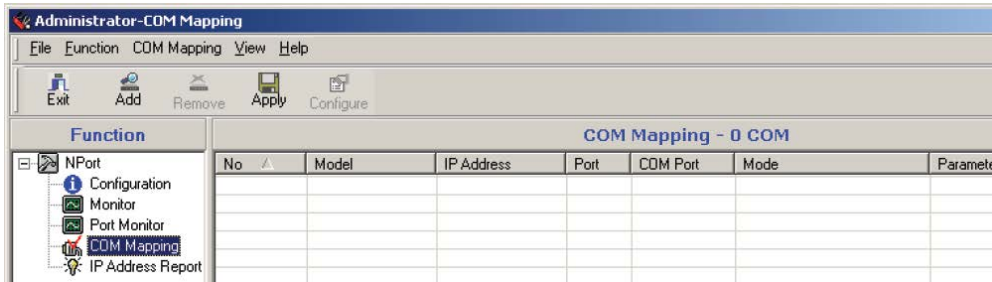

3. Add the target to which you would like to map COM ports.

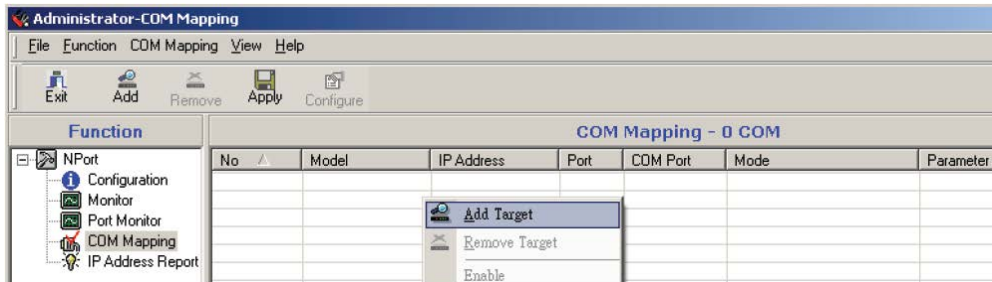

4. The NPort 5200 list that appears is the list generated by the previous Broadcast Search. Select the NPort 5200 to which you would like to map COM ports.

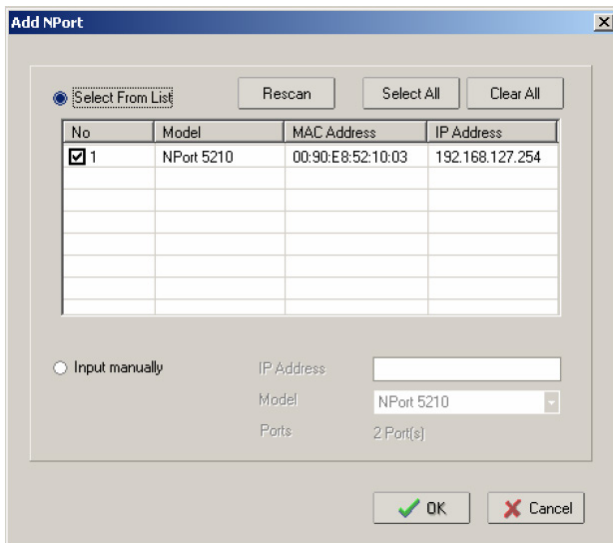

5. Select **COM Settings** to modify COM No., default setting, etc.

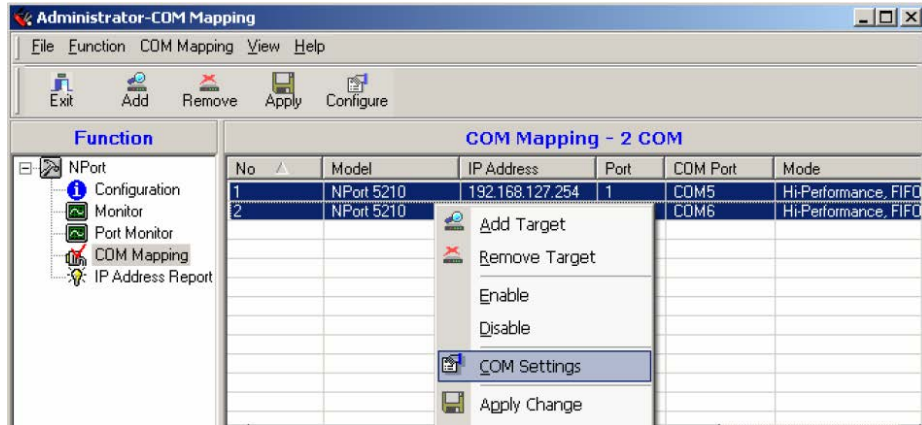

6. Select the **COM Number**.

COM ports that are “In use” or “Assigned” will also be indicated in this drop-down list.

If you select multiple serial ports or multiple NPort 5200s, remember to check the “Auto Enumerating” function to use the COM No. you select as the first COM No.

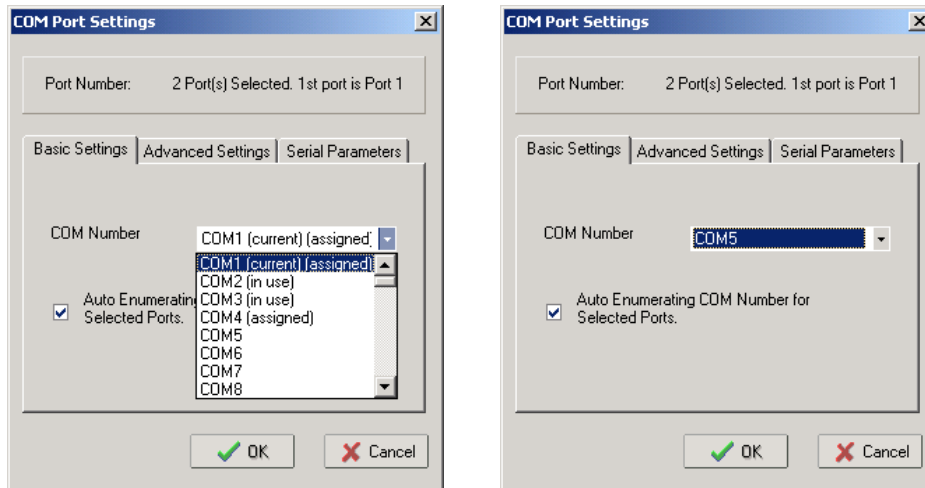

7. **Hi-performance** mode is the default for Tx mode. If the driver completes sending data out to the NPort 5200, the driver will respond “Tx Empty” to the program.

Under **classical mode**, the driver will not notify the user’s program that Tx is completed until all Tx data has been sent out from the NPort 5200. This mode will cause lower throughput. If you want to ensure that all data is sent out before further processing, classical mode is recommended.

Enable/Disable Tx/Rx FIFO. If disabled, the NPort 5200 will send one byte each time the Tx FIFO becomes empty; and an Rx interrupt will be generated for each incoming byte. This will result in a faster response and lower throughput. If you want to use XON/XOFF flow control, we recommend setting FIFO to Disable.

Fast Flush (only flush local buffer)

- We have added one optional Fast Flush function to Moxa’s new NPort Real COM driver. NPort Administrator Suite for 2G NPort adds it after version 1.2.
- For some applications, the user’s program will use the Win32 “PurgeComm()” function before it reads or writes data. With our design, after the program uses this Purge Comm() function, the NPort driver will keep querying the NPort’s firmware several times to make sure there is really no data queued in the NPort firmware buffer, rather than just flushing the local buffer. This kind of design is used because of some special considerations. However, it might take more time (on the order of several hundred milliseconds) than a native COM1, because it needs to work via Ethernet. That’s why the native COM ports on the motherboard can work fast with this function call, but the NPort requires much more time.

In order to accommodate other applications that require a faster response time, the new NPort driver implements a new "Fast Flush" option. Note that by default, this function is disabled.

- To begin with, make sure there are some "PurgeComm()" functions being used in your application program. In this kind of situation, you might find that your NPort exhibits a much poorer operation performance than when using the native COM1 port. Once you have enabled the "Fast Flush" function, you can check to see if there has been an improvement in performance.
- By default, the optional "Fast Flush" function is disabled. If you would like to enable this function, from the "NPort Administrator," double click on the COM ports that are mapped to the NPort, and then select the "Fast Flush" checkbox. You should find that when "Fast Flush" is enabled, the NPort driver will work faster with "PurgeComm()."

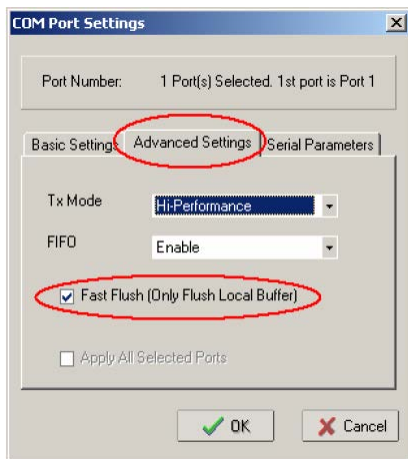

8. The Serial Parameter settings shown here are the default settings when the NPort 5200 is powered on. However, the program can redefine the serial parameters to different values after the program opens the port via Win 32 API.

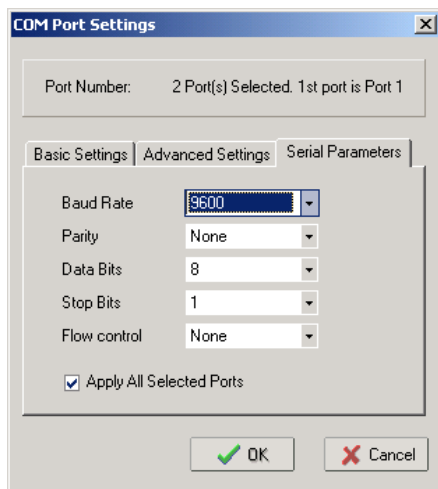

- After setting the COM Mapping, remember to select **Apply Change** to save the information in the host system registry. The host computer will not have the ability to use the COM port until after **Apply Change** is selected.

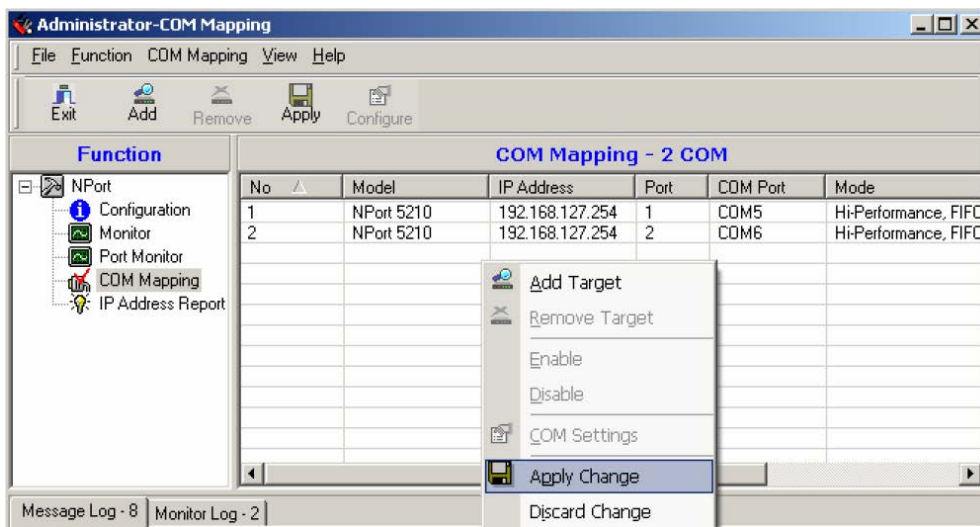

- Select **Discard Change** to tell Administrator NOT to save the COM Mapping information to the host.

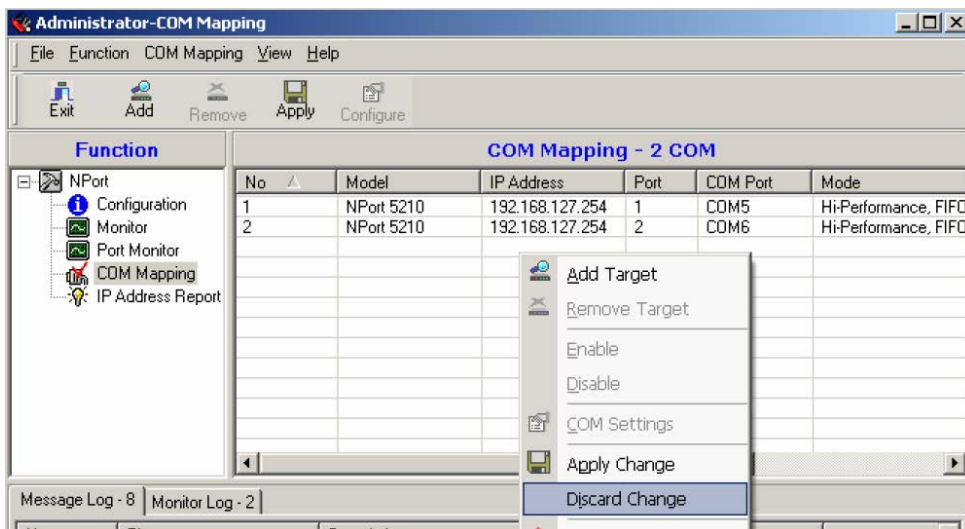

- To save the configuration to a text file, select **Export COM Mapping**. You will then be able to import this configuration file to another host and use the same COM Mapping settings in the other host.

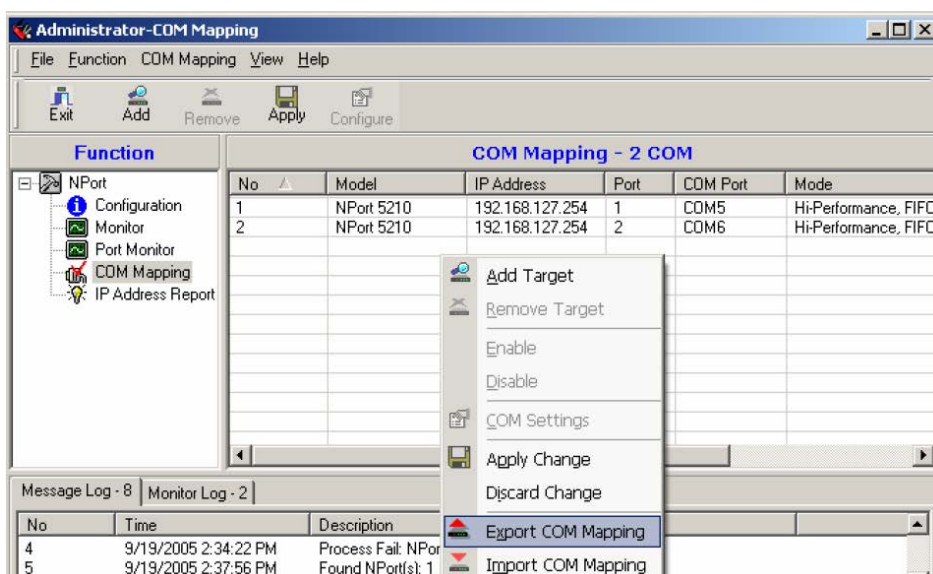

Off-line COM Mapping

1. Add a target by inputting the IP address and selecting the Model Name without physically connecting the NPort 5200 to the network.

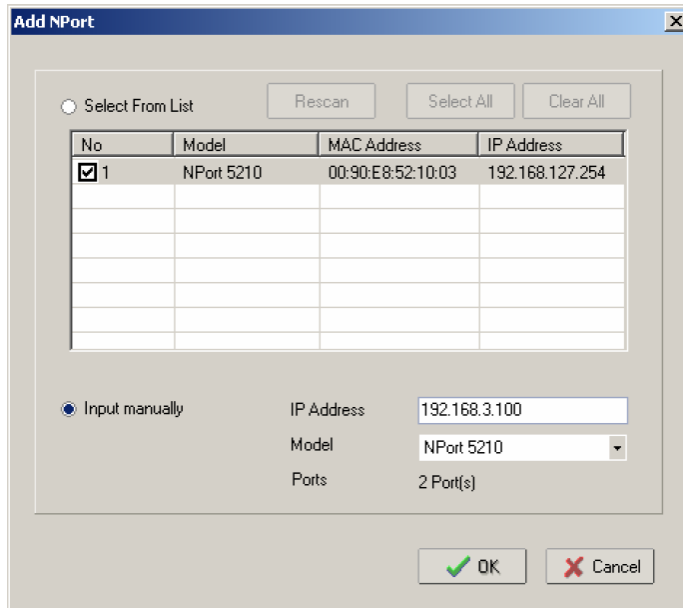

2. Modify the port settings as needed.

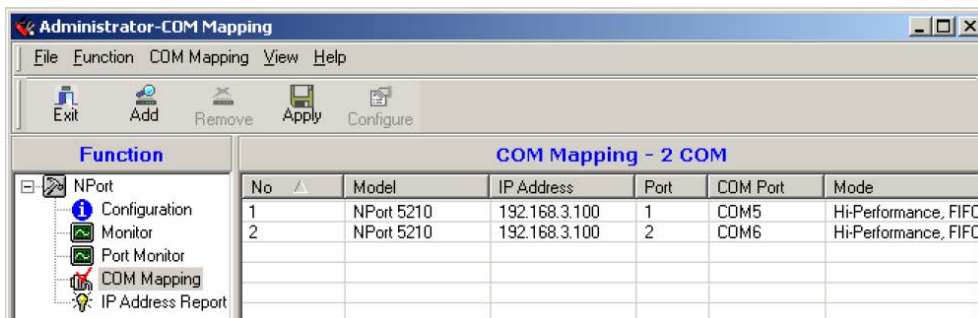

3. Right click in the NPort list section and select **Apply Change**.

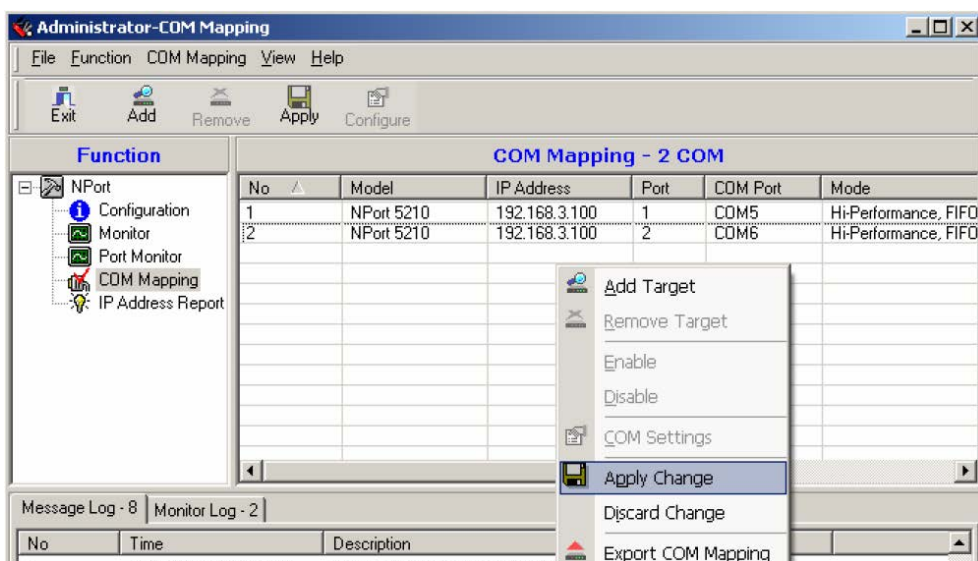

IP Address Report

When NPort 5200 is used in a dynamic IP environment, users must spend more time with IP management tasks. NPort 5200 Series products help out by periodically reporting their IP address to the IP location server, in case the dynamic IP has changed.

1. Configure the NPort 5200 with Dynamic IP settings (DHCP, BOOTP, or DHCP/BOOTP). Assign the remote Auto IP report server's IP address and UDP port.

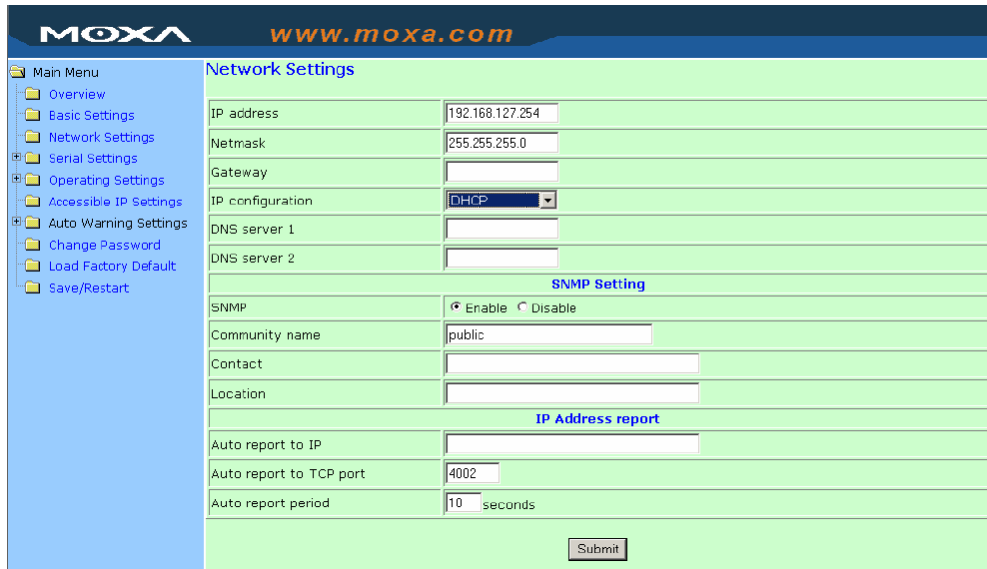

2. Select the **IP Address Report**, and click the right mouse button to select Settings.

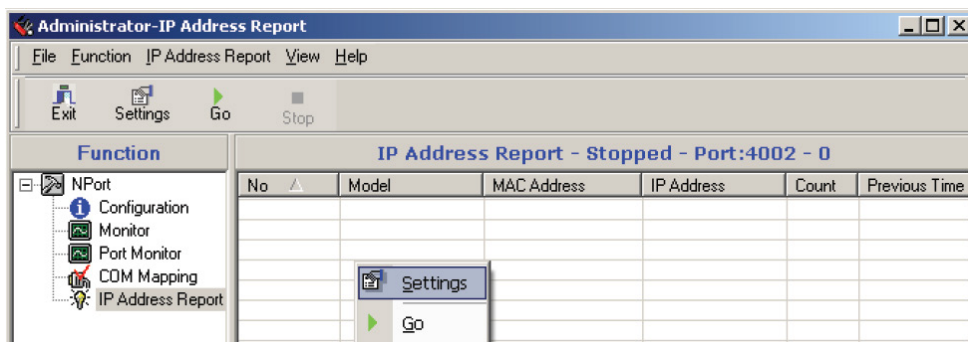

3. Configure the Local Listen Port to be the same as the NPort 5200's "Auto report to UDP port" setting.

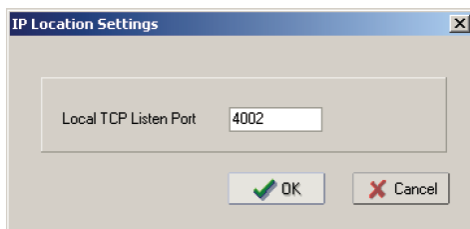

- Click **Go** to start receiving the Auto IP address report from the NPort 5200.

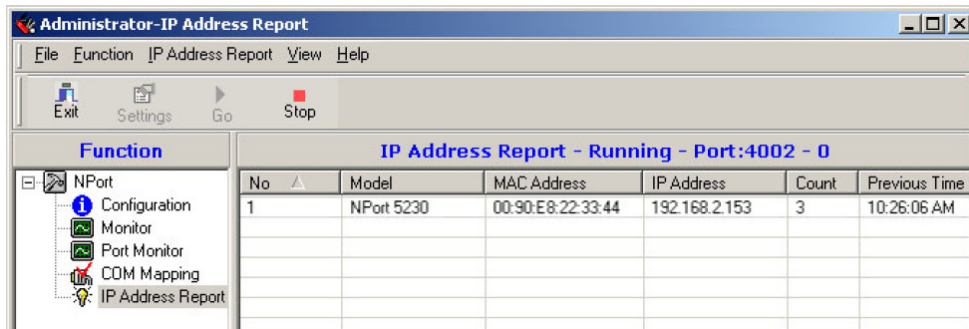
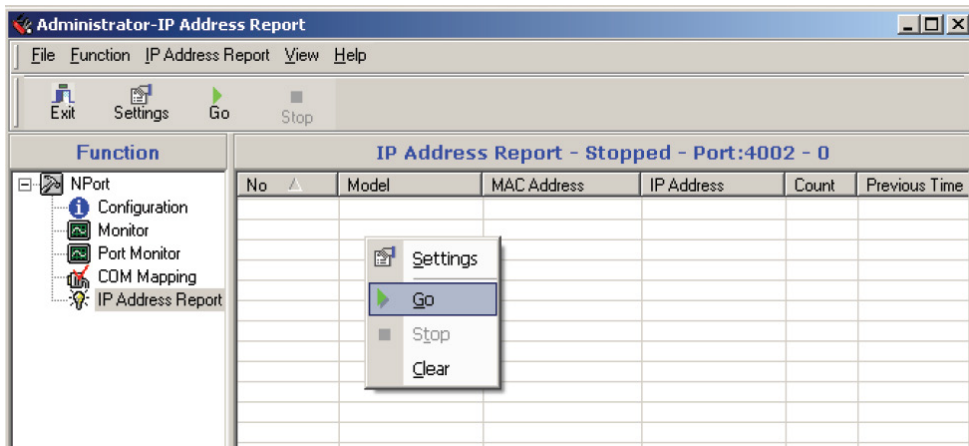

NPort CE Driver Manager for Windows CE

The following topics are covered in this chapter:

- **Overview**
- **Installing NPort CE Driver Manager**
- **Using NPort CE Driver Manager**

Overview

NPort CE Driver Manager is designed for use with NPort 5000 serial ports that are set to Real COM mode. The software manages the installation of drivers that allow you to map unused COM ports on your PC to serial ports on the NPort 5000. These drivers are designed for use with Windows CE 5.0/6.0. When the drivers are installed and configured, devices that are attached to serial ports on the NPort 5000 will be treated as if they were attached to your PC's own COM ports.

Installing NPort CE Driver Manager

1. Copy "NPortCab.cab" to Windows CE and start to install driver by double clicking on it.
2. Click on "OK" to complete the installation when the following screen appears.

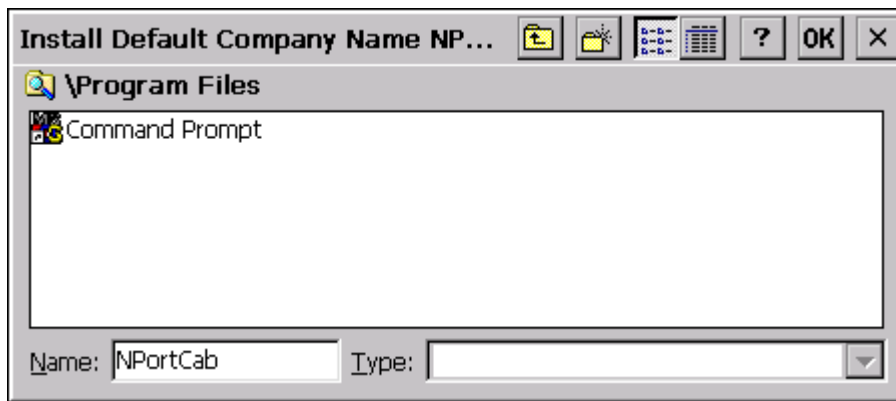

3. Driver installation is now complete and the "NPortCab.cab" icon disappear from the screen. This is normal when installing drivers in Windows CE.

Using NPort CE Driver Manager

After you install NPort CE Driver Manager, you can set up the NPort's serial ports as remote COM ports for your Windows CE. Make sure that the serial port(s) on your NPort are set to Real COM mode when mapping COM ports with NPort CE Driver Manager.

1. Go to **Start → Programs → NPort CE Driver Manager**.

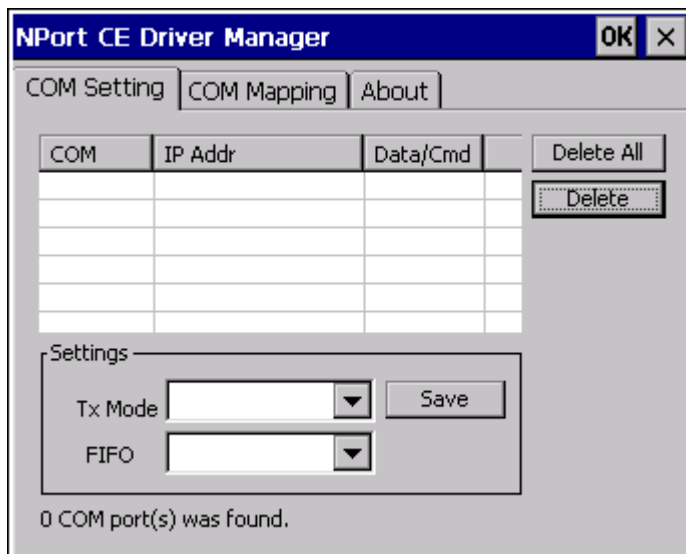

- Click on the **COM Mapping** page and then the "Search" button to scan for NPort servers.

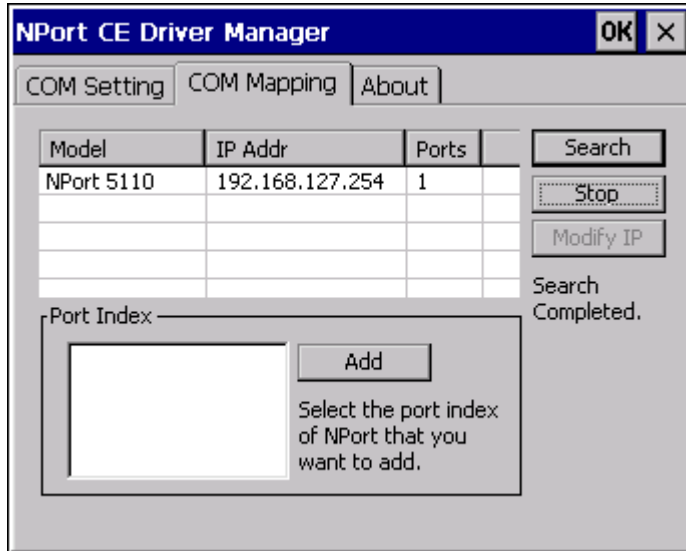

- All NPort servers that were located will appear in the NPort CE Driver Manager window. Click on the server whose COM ports you would like to map to and then select the port index. Note that multiple selections are allowed.
- Select the port(s) at the Port Index and then click on the "Add" button to map to the COM Port(s).

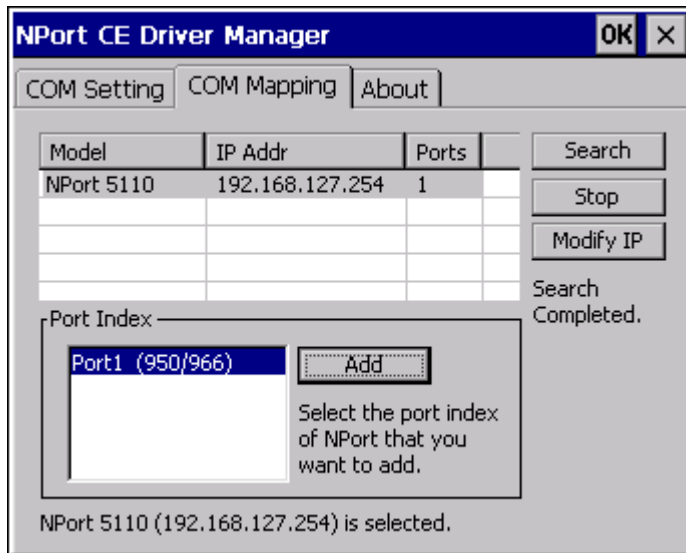

- Return to the **COM Setting** page. You should be able to see the newly mapped COM Port(s).

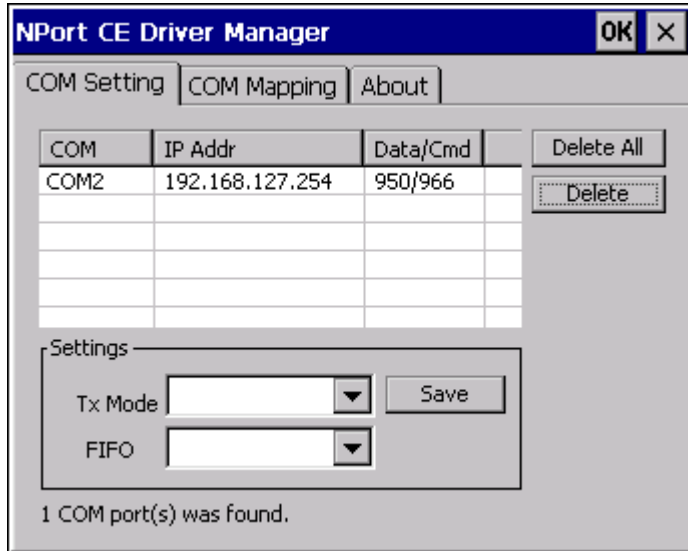

- To configure the settings for a particular COM Port, select the row of the desired port, and then modify the setting in the “Settings” panel, as shown below.

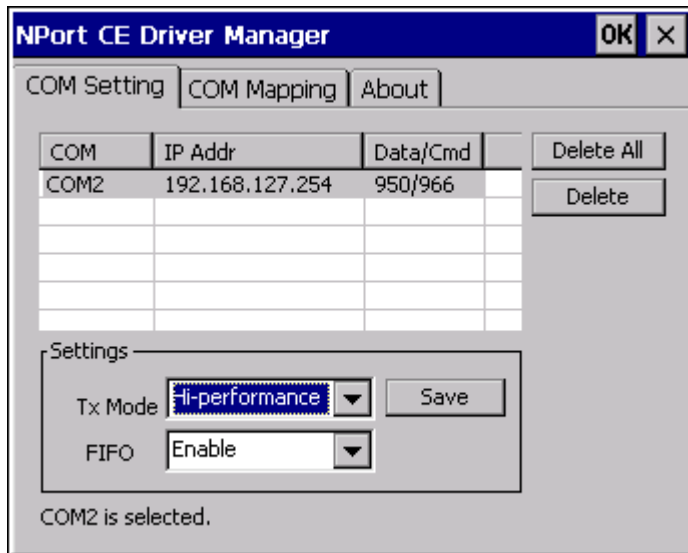

Tx Mode

“Hi-Performance” is the default for Tx mode. After the driver sends data to the NPort server, the driver immediately issues a “Tx Empty” response to the program. Under “Classical mode,” the driver will not send the “Tx Empty” response until after confirmation is received from the NPort server’s serial port. This causes lower throughput. Classical mode is recommended if you want to ensure that all data is sent out before further processing.

FIFO

If FIFO is disabled, the NPort server will transmit one byte each time the Tx FIFO becomes empty, and an Rx interrupt will be generated for each incoming byte. This will result in a faster response and lower throughput.

The following topics are covered in this chapter:

- **Overview**
- **IP Serial LIB Function Groups**
- **Example Program**

Overview

What is IP Serial Library?

IP Serial Library is a Windows library with frequently used serial command sets and subroutines. IP Serial Library is designed to reduce the complexity and poor efficiency of serial communication over TCP/IP. For example, Telnet can only transfer data, but it can't monitor or configure the serial line's parameters.

Why Use IP Serial Library?

For programmers who are familiar with serial communication, IP Serial Library provides well-designed function calls that have the same style as Moxa's PComm Library.

IP Serial Library is amazingly simple and easy to understand. By including it in your VB, C, or Delphi programming environment, you can program your own TCP/IP application with the ability to control serial communication parameters.

NPort 5200 uses 2 TCP ports for communication between the NPort 5200 and host computer's Real COM driver. NPort 5200 uses a data port and command port to provide pure data transfer without decode and encode. Compared to using only one TCP port to control serial communication (such as RFC 2217), IP Serial Library uses a command port to communicate with NPort 5200 from the user's program. IP Serial Library not only runs with excellent efficiency but also runs without any decode or encode problems.

How to install IP Serial Library?

IP Serial Lib comes with the NPort 5200 Administration Suite. Refer to the IPSerial directory for more details about the function definitions.

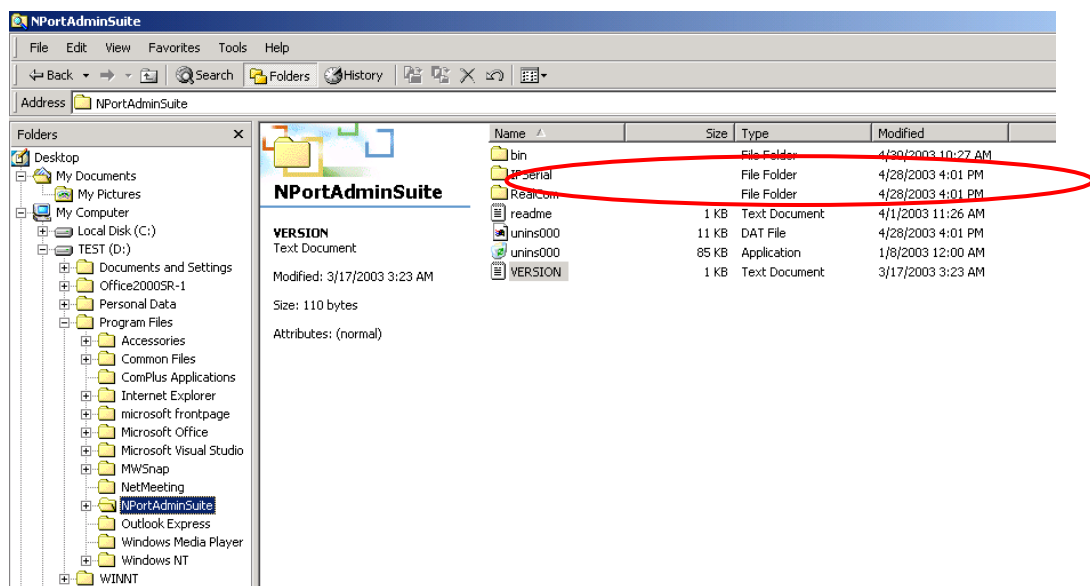

IP Serial LIB Function Groups

Server Control

nsio_init
nsio_end
nsio_resetserver
nsio_checkalive

Port Control

nsio_open
nsio_close
nsio_ioctl
nsio_flowctrl
nsio_DTR
nsio_RTS
nsio_lctrl
nsio_baud
nsio_resetport

Input/Output Data

nsio_read
nsio_SetReadTimeouts
nsio_write
nsio_SetWriteTimeouts

Port Status Inquiry

nsio_lstatus
nsio_data_status

Miscellaneous

nsio_break
nsio_break_on
nsio_break_off
nsio_breakcount

Example Program

```
char NPort 5200-Nip="192.168.1.10";
char buffer[255];
int port = 1;
int portid;
nsio_init();
portid = nsio_open(NPort 5200ip, port);
nsio_ioctl(portid, B9600, (BIT_8 | STOP_1 | P_NONE) );
sleep(1000);
nsio_read(port, buffer, 200);
nsio_close(portid);
nsio_end();

/*data buffer, 255 chars */
/*1st port */
/* port handle */
/*initial IP Serial Library */
/*1st port, NPort 5200 IP=192.168.1.10 */
/*set 9600, N81 */
/* wait for 1000 ms for data */
/* read 200 bytes from port 1 */
/* close this serial port */
/* close IP Serial Library */
```

A

Pinouts and Cable Wiring

The following topics are covered in this appendix:

▣ **Port Pinout Diagrams**

- Ethernet Port Pinouts
- Serial Port Pinouts

▣ **Cable Wiring Diagrams**

- Ethernet Cables
- Serial Cables

Port Pinout Diagrams

Ethernet Port Pinouts

Pin	Signal
1	Tx+
2	Tx-
3	Rx+
6	Rx-

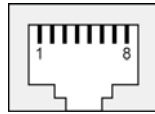

Serial Port Pinouts

8-pin RJ45 RS-232 Port Pinouts for NPort 5210/5210I

Pin	RS-232 Signal
1	DSR
2	RTS
3	GND
4	TxD
5	RxD
6	DCD
7	CTS
8	DTR

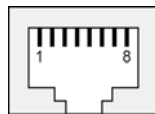

Terminal Block RS-232 & RS-422/485 Pinouts for NPort 5230/5230-T

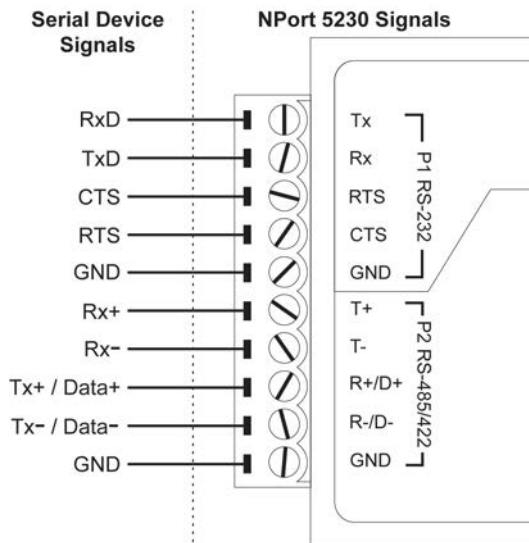

Cable Wiring Diagrams

Ethernet Cables

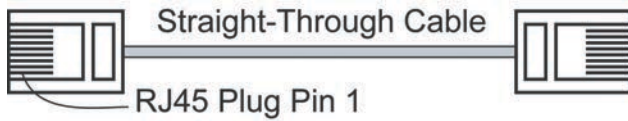

Cable Wiring

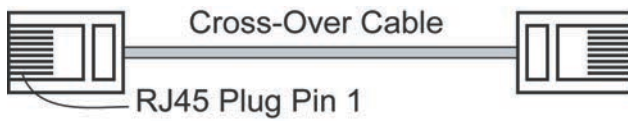
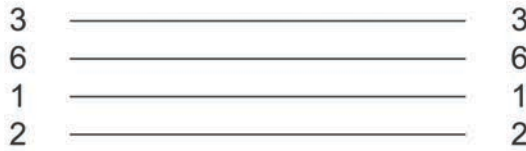

Cable Wiring

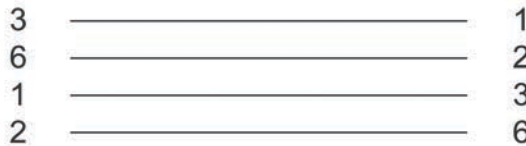

Serial Cables

8-pin RJ45 to DB25 Female for NPort 5210/5210-T (Cable Name: CBL-RJ45F25-150)

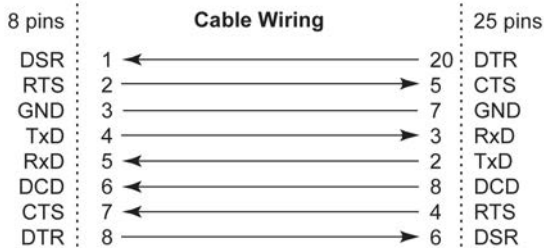
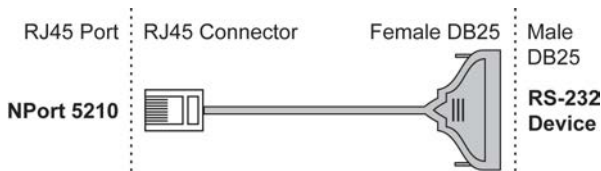

8-pin RJ45 to DB25 Male for NPort 5210/5210-T (Cable Name: CBL-RJ45M25-150)

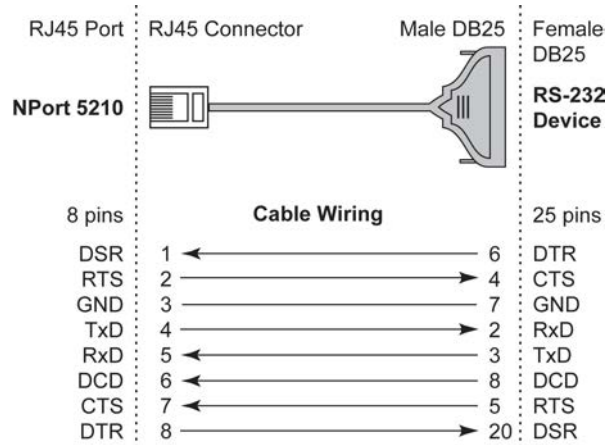

8-pin RJ45 to DB9 Female for NPort 5210/5210-T (Cable Name: CBL-RJ45F9-150)

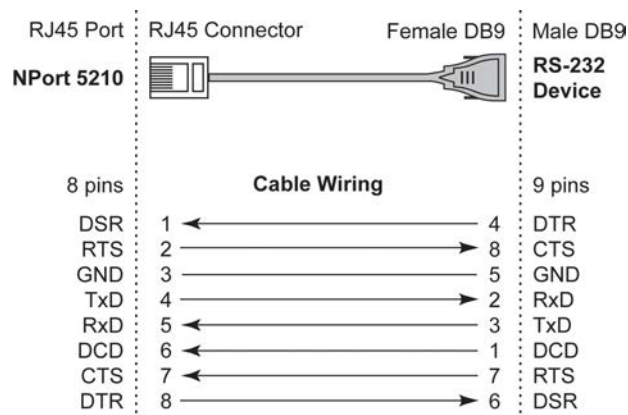

8-pin RJ45 to DB9 Male for NPort 5210/5210-T (Cable Name: CBL-RJ45M9-150)

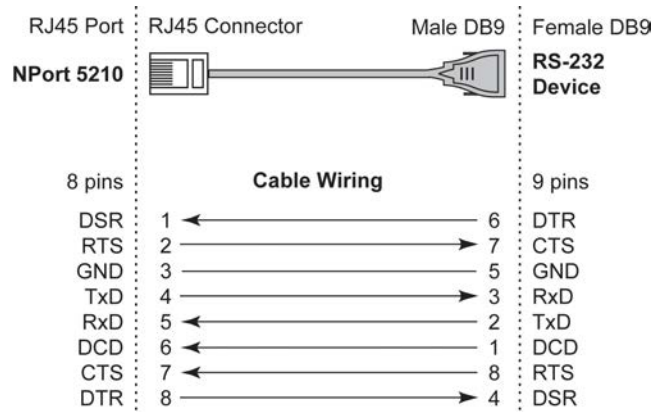

B

Well Known Port Numbers

In this appendix, which is included for your reference, we provide a list of Well Known port numbers that may cause network problems if you set NPort 5200 to one of these ports. Refer to RFC 1700 for Well Known port numbers, or refer to the following introduction from the IANA.

The port numbers are divided into three ranges: the Well Known Ports, the Registered Ports, and the Dynamic and/or Private Ports.

The Well Known Ports range from 0 through 1023.

The Registered Ports range from 1024 through 49151.

The Dynamic and/or Private Ports range from 49152 through 65535.

The Well Known Ports are assigned by the IANA, and on most systems, can only be used by system processes or by programs executed by privileged users. The following table shows famous port numbers among the well-known port numbers. For more details, please visit the IANA website at <http://www.iana.org/assignments/port-numbers>

TCP Socket	Application Service
0	reserved
1	TCP Port Service Multiplexor
2	Management Utility
7	Echo
9	Discard
11	Active Users (sysstat)
13	Daytime
15	Netstat
20	FTP data port
21	FTP CONTROL port
23	Telnet
25	SMTP (Simple Mail Transfer Protocol)
37	Time (Time Server)
42	Host name server (names server)
43	Whois (nickname)
49	(Login Host Protocol) (Login)
53	Domain Name Server (domain)
79	Finger protocol (Finger)
80	World Wide Web HTTP
119	Network news Transfer Protocol (NNTP)
123	Network Time Protocol
213	IPX
160 – 223	Reserved for future use

UDP Socket	Application Service
0	reserved
2	Management Utility
7	Echo
9	Discard
11	Active Users (systat)
13	Daytime
35	Any private printer server
39	Resource Location Protocol
42	Host name server (names server)
43	Whois (nickname)
49	(Login Host Protocol) (Login)
53	Domain Name Server (domain)
69	Trivial Transfer Protocol (TFTP)
70	Gopher Protocol
79	Finger Protocol
80	World Wide Web HTTP
107	Remote Telnet Service
111	Sun Remote Procedure Call (Sunrpc)
119	Network News Transfer Protocol (NNTP)
123	Network Time Protocol (ntp)
161	SNMP (Simple Network Mail Protocol)
162	SNMP Traps
213	IPX (Used for IP Tunneling)

SNMP Agents with MIB II & RS-232 like Groups

NPort 5200 has built-in SNMP (Simple Network Management Protocol) agent software that supports SNMP Trap, RFC1317 RS-232 like groups and RFC 1213 MIB-II. The following table lists the standard MIB-II groups, as well as the variable implementation for NPort 5200.

RFC1213 MIB-II supported SNMP variables:

System MIB	Interfaces MIB	IP MIB	ICMP MIB
SysDescr	ifNumber	ipForwarding	IcmpInMsgs
SysObjectID	ifIndex	ipDefaultTTL	IcmpInErrors
SysUpTime	ifDescr	ipInreceives	IcmpInDestUnreachs
SysContact	ifType	ipInHdrErrors	IcmpInTimeExcds
SysName	ifMtu	ipInAddrErrors	IcmpInParmProbs
SysLocation	ifSpeed	ipForwDatagrams	IcmpInSrcQuenchs
SysServices	ifPhysAddress	ipInUnknownProtos	IcmpInRedirects
	ifAdminStatus	ipInDiscards	IcmpInEchos
	ifOperStatus	ipInDelivers	IcmpInEchoReps
	ifLastChange	ipOutRequests	IcmpInTimestamps
	ifInOctets	ipOutDiscards	IcmpTimestampReps
	ifInUcastPkts	ipOutNoRoutes	IcmpInAddrMasks
	ifInNUcastPkts	ipReasmTimeout	IcmpOutMsgs
	ifInDiscards	ipReasmReqds	IcmpOutErrors
	ifInErrors	ipReasmOKs	IcmpOutDestUnreachs
	ifInUnknownProtos	ipReasmFails	IcmpOutTimeExcds
	ifOutOctets	ipFragOKs	IcmpOutParmProbs
	ifOutUcastPkts	ipFragFails	IcmpOutSrcQuenchs
	ifOutNUcastPkts	ipFragCreates	IcmpOutRedirects
	ifOutDiscards	ipAdEntAddr	IcmpOutEchos
	ifOutErrors	ipAdEntIfIndex	IcmpOutEchoReps
	ifOutQLen	ipAdEntNetMask	IcmpOutTimestamps
	ifSpecific	ipAdEntBcastAddr	IcmpOutTimestampReps
		ipAdEntReasmMaxSize	IcmpOutAddrMasks
		IpNetToMediaIfIndex	IcmpOutAddrMaskReps
		IpNetToMediaPhysAddress	
		IpNetToMediaNetAddress	
		IpNetToMediaType	
		IpRoutingDiscards	

UDP MIB	TCP MIB	SNMP MIB
UdpInDatagrams	tcpRtoAlgorithm	snmpInPkts
UdpNoPorts	tcpRtoMin	snmpOutPkts
UdpInErrors	tcpRtoMax	snmpInBadVersions
UdpOutDatagrams	tcpMaxConn	snmpInBadCommunityNames
UdpLocalAddress	tcpActiveOpens	snmpInASNParseErrs
UdpLocalPort	tcpPassiveOpens	snmpInTooBig
	tcpAttemptFails	snmpInNoSuchNames
Address Translation MIB	tcpEstabResets	snmpInBadValues
AtIfIndex	tcpCurrEstab	snmpInReadOnly
AtPhysAddress	tcpInSegs	snmpInGenErrs
AtNetAddress	tcpOutSegs	snmpInTotalReqVars
AtNetAddress	tcpRetransSegs	snmpInTotalSetVars
	tcpConnState	snmpInGetRequests
	tcpConnLocalAddress	snmpInGetNexts
	tcpConnLocalPort	snmpInSetRequests
	tcpConnRemAddress	snmpInGetResponses
	tcpConnRemPort	snmpInTraps
	tcpInErrs	snmpOutTooBig
	tcpOutRsts	snmpOutNoSuchNames
		snmpOutBadValues
		snmpOutGenErrs
		snmpOutGetRequests
		snmpOutGetNexts
		snmpOutSetRequests
		snmpOutGetResponses
		snmpOutTraps
		snmpEnableAuthenTraps

RFC1317: RS-232 MIB objects

Generic RS-232-like Group	RS-232-like General Port Table	RS-232-like Asynchronous Port Group
rs232Number	rs232PortTable	rs232AsyncPortTable
	rs232PortEntry	rs232AsyncPortEntry
	rs232PortIndex	rs232AsyncPortIndex
	rs232PortType	rs232AsyncPortBits
	rs232PortInSigNumber	rs232AsyncPortStopBits
	rs232PortOutSigNumber	rs232AsyncPortParity
	rs232PortInSpeed	
	rs232PortOutSpeed	

The Input Signal Table	The Output Signal Table
rs232InSigTable	rs232OutSigTable
rs232InSigEntry	rs232OutSigEntry
rs232InSigPortIndex	rs232OutSigPortIndex
rs232InSigName	rs232OutSigName
rs232InSigState	rs232OutSigState

Auto IP Report Protocol

NPort Series provides several ways to configure Ethernet IP addresses. One is DHCP Client. When you set up NPort to use DHCP Client to configure Ethernet IP addresses, it will automatically send a DHCP request over the Ethernet to find the DHCP Server. And then the DHCP Server will send an available IP address to the NPort. The NPort will use this IP address for a period of time after receiving it, but the NPort will send a DHCP request again to the DHCP Server. Once the DHCP Server realizes that this IP address is to be released to other DHCP Clients, the NPort then will receive a different IP address. For this reason, users sometimes find that the NPort will use different IP addresses, not a fixed IP address.

In order to know which IP address the NPort is using, you need to set up parameters in Network Settings via Web browser. The figure below shows the NPort Web console configuration window. Enter the IP address and the Port number of the PC that you want to send this information to.

The screenshot shows the MOXA web console interface. On the left is a 'Main Menu' sidebar with options like Overview, Basic Settings, Network Settings, Serial Settings, Operating Settings, Accessible IP Settings, Auto Warning Settings, Monitor, Change Password, Load Factory Default, and Save/Restart. The main area is titled 'Network Settings' and contains several configuration fields: IP address (192.168.127.254), Netmask (255.255.0.0), Gateway (255.255.255.255), IP configuration (DHCP), DNS server 1, and DNS server 2. Below these is the 'SNMP Setting' section with radio buttons for Enable (selected) and Disable, and fields for Community name (public), Contact, and Location. The 'IP Address report' section is circled in red and includes fields for Auto report to IP (192.168.2.149), Auto report to TCP port (4002), and Auto report period (10 seconds). A 'Submit' button is located at the bottom right of the configuration area.

Auto IP Report Format

"Moxa", 4 bytes	Info[0]	Info[1]	...	Info[n]
-----------------	---------	---------	-----	---------

Info [n]

Field	ID	Length	Data
Length	1	1	Variable, Length is "Length Field"

ID List

ID Value	Description	Length	Note
1	Server Name	Variable	ASCII char
2	Hardware ID	2	Little-endian
3	MAC Address	6	6 bytes MAC address. If the MAC address is "00-90-E8-01-02-03", the MAC[0] is 0, MAC[1] is 0x90(hex), MAC[2] is 0xE8(hex), and so on.
4	Serial Number	4, DWORD	Little-endian
5	IP Address	4, DWORD	Little-endian
6	Netmask	4, DWORD	Little-endian
7	Default Gateway	4, DWORD	Little-endian
8	Firmware Version	4, DWORD	Little-endian Ver1.3.4= 0x0103040
9	AP ID	4, DWORD	Little-endian

AP ID & Hardware ID Mapping Table

AP ID	Hardware ID	Product
0x80005000	0x0504	NPort 5410
0x80005000	0x0534	NPort 5430
0x80005000	0x1534	NPort 5430I
0x80000312	0x0312	NPort 5230
0x80000312	0x0322	NPort 5210
0x80000312	0x0332	NPort 5232
0x80000312	0x1332	NPort 5232I
0x80005610	0x5618	NPort 5610-8
0x80005610	0x5613	NPort 5610-16
0x80005610	0x5638	NPort 5630-8
0x80005610	0x5633	NPort 5630-16

Compliance Notice



CE Warning

This is a Class A product. In a domestic environment, this product may cause radio interference in which case the user may be required to take appropriate measures.

Federal Communications Commission Statement

FCC - This device complies with part 15 of the FCC Rules. Operation is subject to the following two conditions: (1) This device may not cause harmful interference, and (2) this device must accept any interference received, including interference that may cause undesired operation.



FCC Warning

This equipment has been tested and found to comply with the limits for a Class A digital device, pursuant to part 15 of the FCC Rules. These limits are designed to provide reasonable protection against harmful interference when the equipment is operated in a commercial environment. This equipment generates, uses, and can radiate radio frequency energy and, if not installed and used in accordance with the instruction manual, may cause harmful interference to radio communications. Operation of this equipment in a residential area is likely to cause harmful interference in which case the user will be required to correct the interference at his own expense.