

Moxa Industrial Smart Ethernet Switch User's Manual

Edition 1.0, January 2017

www.moxa.com/product

Models covered by this manual:

SDS-3008 series



© 2017 Moxa Inc. All rights reserved.

Moxa Industrial Smart Ethernet Switch User's Manual

The software described in this manual is furnished under a license agreement and may be used only in accordance with the terms of that agreement.

Copyright Notice

© 2017 Moxa Inc. All rights reserved.

Trademarks

The MOXA logo is a registered trademark of Moxa Inc.
All other trademarks or registered marks in this manual belong to their respective manufacturers.

Disclaimer

Information in this document is subject to change without notice and does not represent a commitment on the part of Moxa.

Moxa provides this document as is, without warranty of any kind, either expressed or implied, including, but not limited to, its particular purpose. Moxa reserves the right to make improvements and/or changes to this manual, or to the products and/or the programs described in this manual, at any time.

Information provided in this manual is intended to be accurate and reliable. However, Moxa assumes no responsibility for its use, or for any infringements on the rights of third parties that may result from its use.

This product might include unintentional technical or typographical errors. Changes are periodically made to the information herein to correct such errors, and these changes are incorporated into new editions of the publication.

Technical Support Contact Information

www.moxa.com/support

Moxa Americas

Toll-free: 1-888-669-2872

Tel: +1-714-528-6777

Fax: +1-714-528-6778

Moxa Europe

Tel: +49-89-3 70 03 99-0

Fax: +49-89-3 70 03 99-99

Moxa India

Tel: +91-80-4172-9088

Fax: +91-80-4132-1045

Moxa China (Shanghai office)

Toll-free: 800-820-5036

Tel: +86-21-5258-9955

Fax: +86-21-5258-5505

Moxa Asia-Pacific

Tel: +886-2-8919-1230

Fax: +886-2-8919-1231

Table of Contents

1. About this Manual	1-1
2. Quick Start Guide	2-1
Connecting to the Switch for the First Time	2-2
Important Reminders	2-4
Change the Default Password!	2-4
Configure the Smart Switch's Date and Time Settings	2-4
UI Dashboard	2-5
Management Bar Buttons and Functionality	2-5
Configuration Panel Icons and Functionality	2-7
Detailed Descriptions of Management Bar Buttons	2-8
Management Interface Instructions	2-8
Port Mirror Instructions	2-9
Inventory Report Download	2-10
Log File Backup Instructions	2-10
Configuration Backup and Restore Instructions	2-12
Firmware Upgrade Instructions	2-14
User Account Instructions	2-15
3. Management Functions	3-1
Switch Information	3-2
System Information	3-2
Network Information	3-3
Date and Time Information	3-5
Switch Panel and Profile	3-9
Switch Panel and Statistics	3-9
Industrial Protocols and SNMP Settings	3-10
Port Settings	3-16
RSTP Settings	3-17
VLAN Settings	3-20
Switch Log	3-22
Switch Log Table	3-22
Warning Notification Settings	3-23
A. The STP/RSTP Concept	A-1
What is STP?	A-1
How STP Works	A-2
STP Requirements	A-2
STP Calculation	A-3
STP Configuration	A-3
STP Reconfiguration	A-3
Differences between STP and RSTP	A-3
B. The Virtual LAN (VLAN) Concept	B-1
What is a VLAN?	B-1
Benefits of VLANs	B-1
VLANs and the Rackmount switch	B-2
Managing a VLAN	B-2
Communication between VLANs	B-2
VLANs: Tagged and Untagged Membership	B-2
Sample Applications of VLANs Using Moxa Switches	B-3

About this Manual

Thank you for purchasing a Moxa Industrial Smart Ethernet Switch. Read this user's manual to learn how to connect your Moxa Industrial Smart Ethernet Switch to Ethernet-enabled devices used for industrial applications.

Read the following two chapters to learn how to use your Moxa smart switch:

▣ **Chapter 2: Quick Start Guide**

In chapter 2, we explain how to configure your smart switch the first time you use it, and give an overview of the management function icons that are accessible from the switch's browser-based UI. The easy-to-recognize icons that appear on the UI dashboard effectively reduce deployment time, simplify maintenance, and enhance manageability.

▣ **Chapter 3: Management Functions**

In chapter 3, we explain in detail how to access, configure, and use the various management functions supported by your Moxa smart switch. All of the functions can be easily accessed and configured through a web browser.

Quick Start Guide

The Moxa industrial smart Ethernet switch has a browser-based UI with easy-to-recognize icons on the UI dashboard to effectively reduce deployment time, simplify maintenance, and enhance manageability. Read this chapter before using your Moxa smart switch for the first time.

The following topics are covered in this chapter:

- ❑ **Connecting to the Switch for the First Time**
- ❑ **Important Reminders**
 - Change the Default Password!
 - Configure the Smart Switch's Date and Time Settings
- ❑ **UI Dashboard**
- ❑ **Management Bar Buttons and Functionality**
- ❑ **Configuration Panel Icons and Functionality**
- ❑ **Detailed Descriptions of Management Bar Buttons**
 - Management Interface Instructions
 - Port Mirror Instructions
 - Inventory Report Download
 - Log File Backup Instructions
 - Configuration Backup and Restore Instructions
 - Firmware Upgrade Instructions
 - User Account Instructions

Connecting to the Switch for the First Time

To connect to your Moxa smart switch for the first time, use a standard Ethernet cable to connect your computer's Ethernet port to any of the switch's Ethernet ports. You will need to know the switch's factory default settings, which are shown in the following table:

Smart Switch Factory Default Settings

Configuration Item	Default Setting
IP Address	192.168.127.253
Subnet Mask	255.255.255.0
Username	admin, user
Password	moxa
Management VLAN	1

Step 1: Configure your computer's network settings

To establish a connection between your computer and the Moxa smart switch, the smart switch and computer must be connected to the same logical subnet.

For example, for a Windows computer, open the **Internet Protocol Version 4 (TCP/IPv4) Properties** page, set subnet mask to 255.255.255.0, and the IP address to 192.168.127.252.

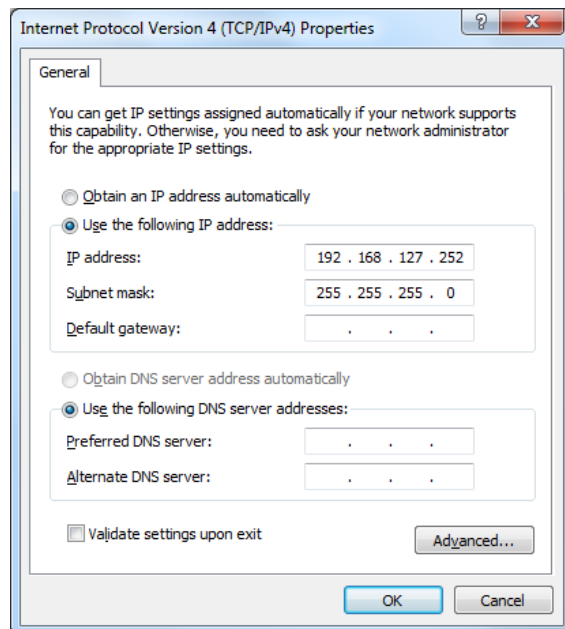

Step 2: Configure the resolution of your computer screen

For best results, set the resolution of your PC's display to 1024 x 768 pixels.

Step 3: Connect to the smart switch's browser-based UI

1. Open your computer's web browser and enter the IP address (default: 192.168.127.253) of the connected smart switch in the Address or URL field at the top of the browser window.

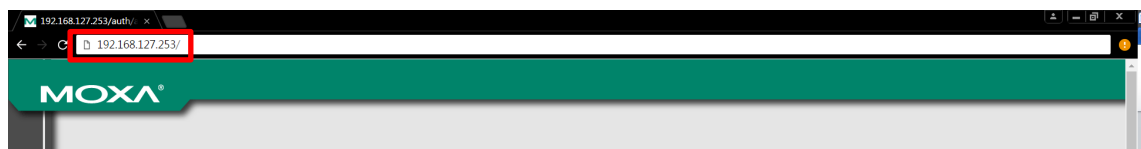

- When the smart switch’s web console opens, type in the Username (default: admin) and Password (default: moxa) and then click the Login button to log in.

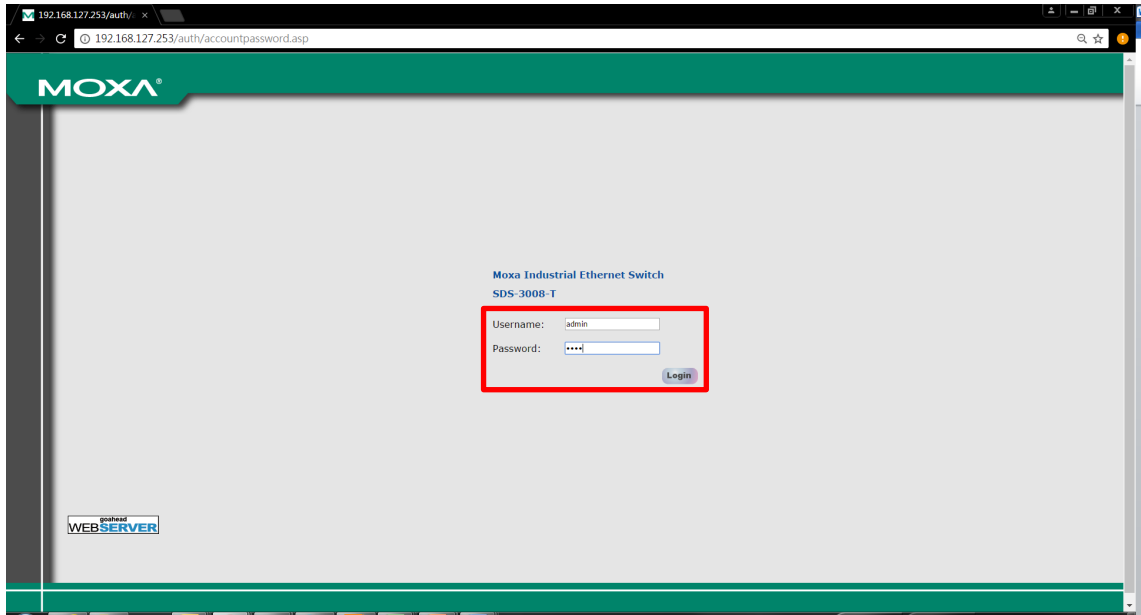

- Click **Continue** on the welcome page to proceed.

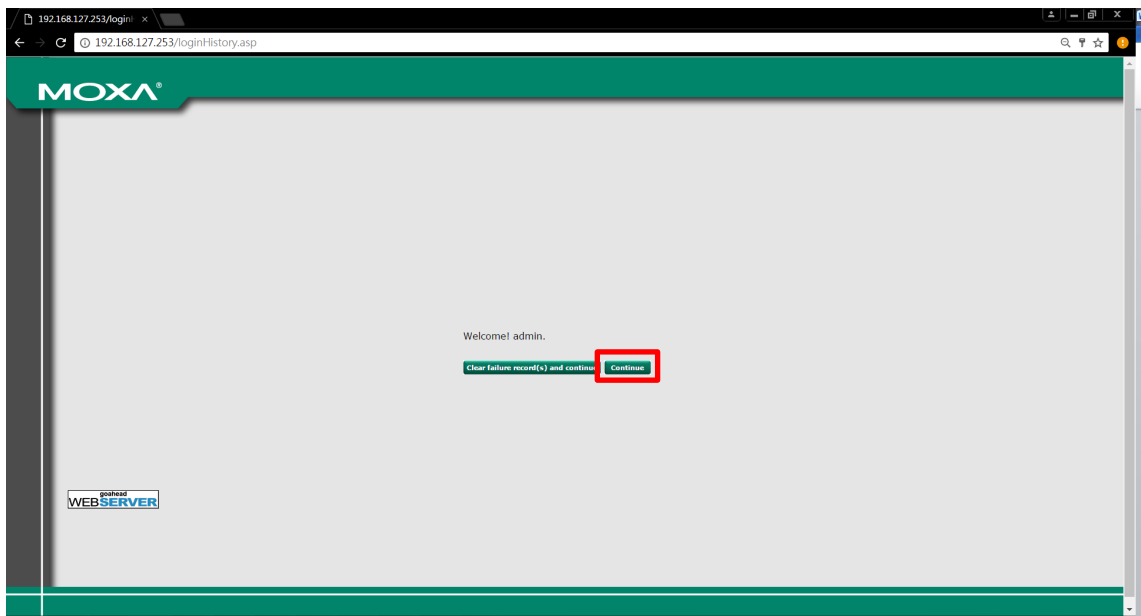

4. After logging in, you may need to wait a few moments for the web console to appear.

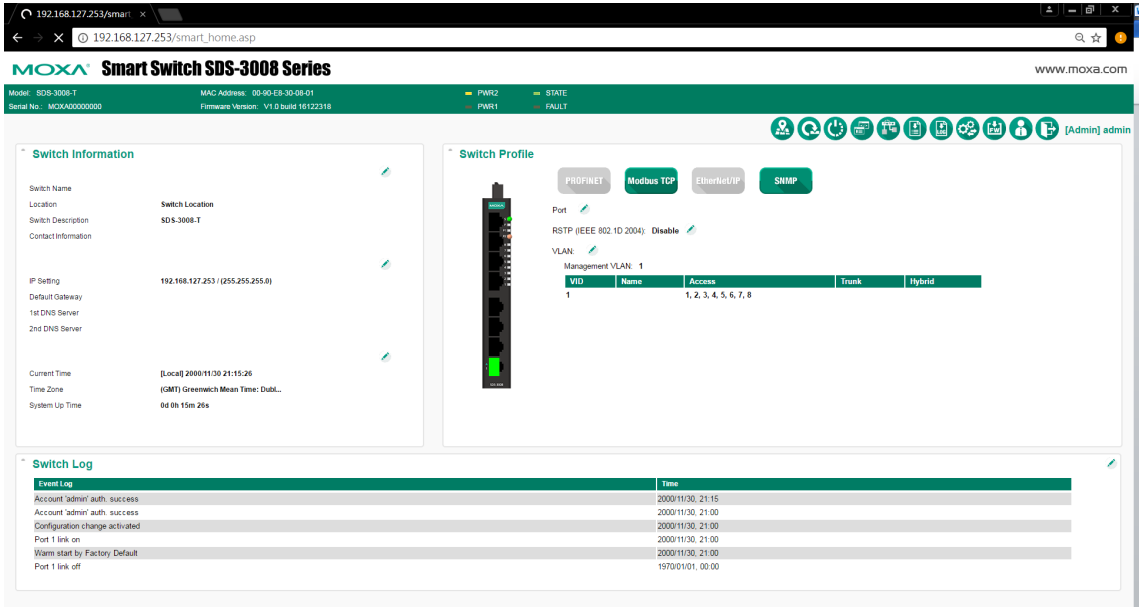

Important Reminders

Change the Default Password!



Be sure to **change the password** of your Moxa smart switch the first time you use the switch.

To reduce the chance that hackers will access your smart switch and your network, be sure to change the factory default password (moxa) the first time you use the switch. If the password has not been changed, the following popup window will appear each time you log in:

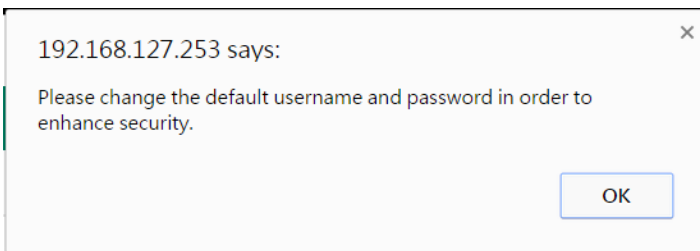

See the **User Account Instructions** section in chapter 3 to learn how to change the password.

Configure the Smart Switch's Date and Time Settings

Configure the switch's internal date and time settings the first time you log in to your Moxa smart switch. Setting the correct date and time is important because the switch's log and trap functions use a date/time stamp.

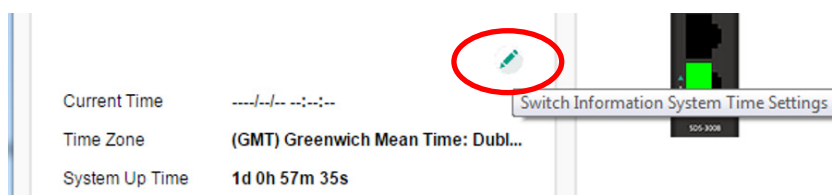

See the **Date and Time Information** section in the chapter 3 for details.

UI Dashboard

The dashboard of the Moxa smart switch’s browser-based UI consists of three parts:



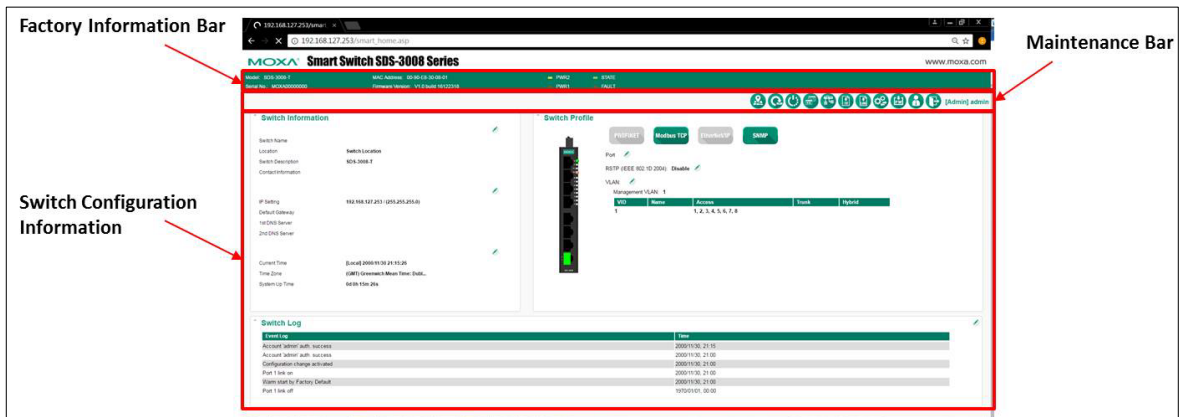

1. **Switch Information Bar:** Displays basic switch information, including the model name, MAC address, serial number, and firmware version.
2. **Management Bar:** The clickable icons (referred to below as “management buttons” or simply “buttons”) displayed on the Management Bar can be used to perform various management functions. For a detailed explanation of each button, refer to the **Management Bar Icons and Functionality** section later in this chapter.
3. **Configuration Panels:** The configuration panels section includes three panels: Switch Information, Switch Profile, and Switch Log. Click any of the pencil icons to configure the items nearest the icon. For a detailed explanation of each configuration item, refer to **Chapter 3: Management Functions**.





Management Bar Buttons and Functionality





The 11 icons on the Moxa smart switch’s management bar can be used to perform a variety of management-type operations. The name of each button and the button’s functionality are detailed below:

Icon	Function	Description
	Switch Locator	Click the Switch Locator button to locate the switch you are currently connected to. When the button is clicked, the STATE and FAULT LEDs on the switch will blink green and red, respectively, twice per second for a period of 30 seconds.
	Factory Default	Click the Factory Default button to restore the smart switch settings to factory default values. A popup window will appear asking you to click OK to proceed with the reset action, or Cancel to cancel the request. A factory reset button is also located on the top panel of the switch itself. Refer to the SDS-3008 Series Quick Installation Guide , which can be downloaded from Moxa’s website, for instructions on how to use the reset button.
	Restart System	Click the Restart System button to initiate a “warm restart” of the Moxa smart switch’s operating system. A popup window will appear asking you to click OK to proceed with the reset action, or Cancel to cancel the request.

Icon	Function	Description
	Management Interface	Click the Management Interface button to update the TCP Port numbers for various web protocols, the maximum number of users who can be logged in simultaneously to various protocols, and the auto logout time setting. These settings can be used to better control network security. For a detailed explanation of each setting, see the Management Interface Instructions section later this chapter.
	Port Mirror	Click the Port Mirror button to configure a monitored port, sniffer mode, and mirror port. The mirror port can be configured to transmit the same data being transmitted to and/or from the monitored port, allowing the network administrator to “sniff” the observed port to keep an eye on network activity. For a detailed explanation of each setting, see the Port Mirror Instructions section later in this chapter. NOTE: Only sniffed traffic will be transmitted through the mirror port. NOTE: When the port mirror function is activated, the gray ports on the Port Mirror Button will change to blue.
	Inventory Report Download	Click the Inventory Report Download button to download a text file that summarizes information related to the switch. The text file can be used to improve device management and for archiving. The text file will be named as follows: “[Switch Name]_inventory_report.txt”. For an overview of the content that will be downloaded, see the Inventory Report Download section later in this chapter.
	Log File Backup	Click the Log File Backup button to back up the smart switch’s log files. When the Log File Backup dialog window opens, select one of three backup methods: to a local drive, to a remote TFTP server, or save to Moxa Auto Backup Configurator (ABC-02). You may also select the “Automatically back up the event log to prevent it from being overwritten” option at the bottom of the dialog window. For a detailed explanation of the settings, see the Log File Backup Instructions section later in this chapter. NOTE: Moxa industrial smart Ethernet switches can store a maximum of 1000 event log entries. When the 1000-entry storage limit is reached, the switch will overwrite and delete the oldest saved event log.
	Configuration Backup and Restore	Click the Configuration Backup and Restore button to enable your Moxa smart switch’s configuration backup and restore function. When the settings window opens, select one of three backup and restore options: using a local computer, using a remote TFTP server, or using a Moxa Auto Backup Configurator (ABC-02). You may also require the configuration file to be encrypted, and configure the configuration backup and restore function to automatically load configurations from and back up configurations to an ABC-02 device attached to the switch. For a detailed explanation of the settings, see the Configuration Backup and Restore Instructions section later in this chapter. NOTE: When encryption is enabled, you must set a password, and use the password when restoring the configuration from a backup file.

Icon	Function	Description
	Firmware Upgrade	Click the Firmware Upgrade button to upgrade the firmware through either a local drive, remote TFTP server, or Auto Backup Configurator (ABC-02). For a detailed description of this function, see the Firmware Upgrade Instructions section later in this chapter.
	User Account	Click the User Account button to create, manage, or remove accounts and corresponding settings. For a detailed description of this setting, see the User Account Instructions section later in this chapter. NOTE: The active username and the user's corresponding access right are displayed to the right of the Management Bar buttons. For example: [Admin] admin
	Logout	Click the Logout button to manually log out of the switch's web console. Note that you can use the Management Interface function described above to configure the switch to automatically log out of the web console if the connection with the user is idle for a preset time period.

Configuration Panel Icons and Functionality

Icon	Function	Description
	Edit	Click any of the Edit buttons in the Switch Configuration Information section to edit the settings of items located near the edit icon.
   	Industrial Protocols and SNMP Profiles	<p>The Moxa smart switch supports three industrial protocols: PROFINET, EtherNet/IP, and Modbus TCP; and one management protocol: SNMP. When activated, PROFINET, Modbus TCP, EtherNet/IP, and/or SNMP statuses are transmitted to, and instructions are received from, devices connected to the switch. Such information can be displayed on a SCADA HMI or NMS system.</p> <p>If the protocol is active, the protocol button will be green (as shown at the left). If the protocol is inactive, the protocol button will be gray. Click the protocol button once to change the protocol from active to inactive or vice versa.</p> <p>NOTE: If you need to integrate the smart switch with an EtherNet/IP network for I/O operations, then IGMP Snooping and IGMP Query may be needed; when you click the EtherNet/IP button, the smart switch enables IGMP Snooping and IGMP Query automatically.</p> <p>NOTE: To configure additional SNMP settings, left click the SNMP button to enter the SNMP settings page.</p>

Detailed Descriptions of Management Bar Buttons

Management Interface Instructions

The following screenshot gives an overview of the management interface settings page, including details of each parameter.

Management Interface

Enable HTTP TCP Port

Enable HTTPS TCP Port

Enable Telnet TCP Port

Enable SSH TCP Port

Enable Moxa Service TCP Port UDP Port

Enable Moxa Service (Encrypted) TCP Port UDP Port

Maximum Amount of Users for Web Login (1-10)

Maximum Amount of Users for SSH and TENLET Login (1-5)

Auto Logout Settings (min) (0-1440; 0 for Disable)

Apply

Enable HTTP

Setting	Description	Factory Default
Select/Deselect	Select the checkbox to enable HTTP.	TCP Port: 80

Enable HTTPS

Setting	Description	Factory Default
Select/Deselect	Select the checkbox to enable HTTPS.	TCP Port: 443

Enable Telnet

Setting	Description	Factory Default
Select/Deselect	Select the checkbox to enable Telnet.	TCP Port: 23

Enable SSH

Setting	Description	Factory Default
Select/Deselect	Select the checkbox to enable SSH.	TCP Port: 22

Enable Moxa Service

Setting	Description	Factory Default
Select/Deselect	Select the checkbox to enable Moxa Service. NOTE: Moxa Service only applies to the Moxa network management software suite.	TCP Port: 4000 UDP Port: 4000

Enable Moxa Service (Encrypted)

Setting	Description	Factory Default
Select/Deselect	Select the checkbox to enable Moxa Service (Encrypted). NOTE: Moxa Service (Encrypted) only applies to the Moxa network management software suite.	TCP Port: 443 UDP Port: 40404

Maximum Login Users for HTTP+HTTPS

Setting	Description	Factory Default
Integer (1 to 10)	Sets the maximum number of users who can log in to HTTP and HTTPS simultaneously.	5

Auto Logout Setting (min)

Setting	Description	Factory Default
Integer (0 to 1440)	Sets the web auto logout period. (Enter 0 to disable this function.)	5

NOTE: Press **Apply** once all settings have been properly set to activate the function.

Port Mirror Instructions

The following screenshot gives an overview of the port mirror settings page and details of each parameter.



Port Mirror

Setting	Description
Monitored Port	Select which ports will be monitored.
Sniffer Mode	Select one of the following three watch direction options: <ul style="list-style-type: none"> • RX: Select this option to monitor only those data packets coming into the Moxa switch’s port. • TX: Select this option to monitor only those data packets being sent out through the Moxa switch’s port. • TX/RX: Select this option to monitor data packets both coming into, and being sent out through, the Moxa switch’s port.
Mirror Port	Select the number of the port that will be used to monitor the activity of the monitored port.

NOTE: Press **Apply** once all settings have been properly set to activate the function.

Inventory Report Download

This text file will be downloaded and saved with the following filename:

[Switch Name]_inventory_report.txt.

Information like factory and switch Information will be summarized in a systematic way in this file. Users can also import this text file into Microsoft Excel. Here is example:

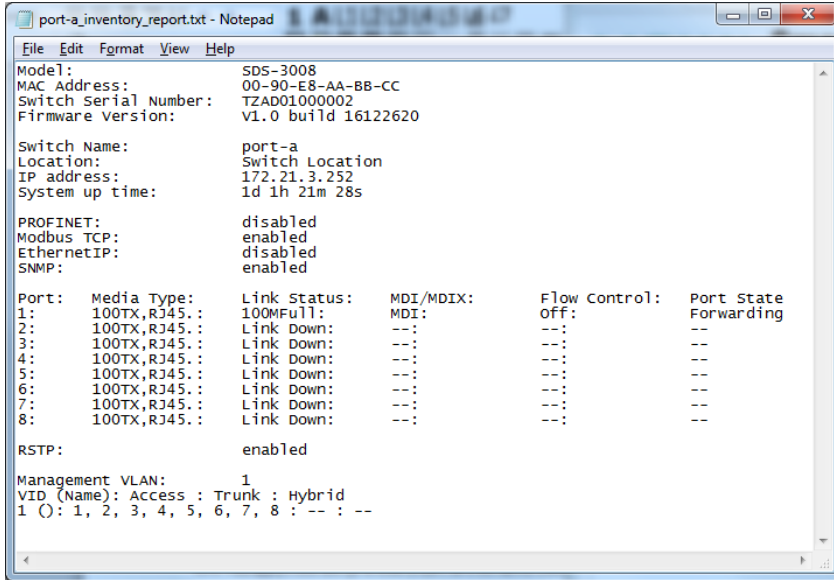

Log File Backup Instructions

The log file backup settings page has two main sections. The first section can be used to manually select the destination to which the log file will be saved, and the second part can be used to activate the automatic backup of the event log to prevent it from being overwritten.

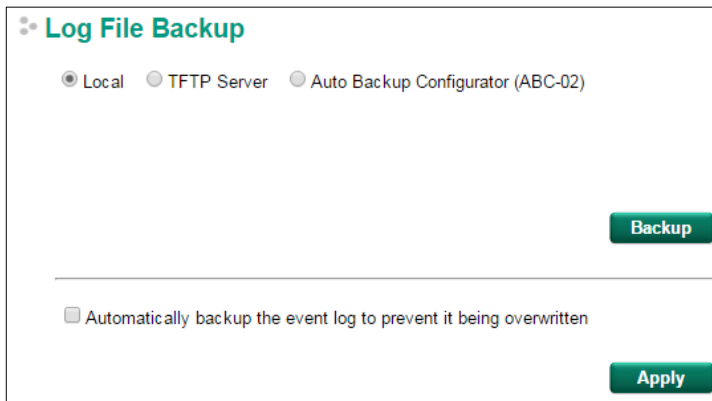

Log File Backup Method

Setting	Description	Factory Default
Local	Select Local and click the Backup button to back up the log file to a local drive.	Local
TFTP Server	Select TFTP Server , enter the Server IP and File Name, and then click the Backup button to back up the log file.	
Auto Backup Configurator (ABC-02)	Select Auto Backup Configurator (ABC-02) and then click Backup to save the configuration file to a connected ABC-02. The file will be saved in the ABC-02's Moxa folder with filename and extension as Sys.log .	

NOTE: Select the proper method and press **Backup** to start the backup.

Automatically Backup the Event Log

Setting	Description	Factory Default
Automatically backup the event log to prevent it from being overwritten	<p>This function is designed to maintain a long-term record of the switch’s log files. Moxa Ethernet switches are capable of saving 1000 event log entries. When the 1000-entry storage limit is reached, the switch over write the oldest saved event log. The ABC-02 can be used to back up these event logs. When the number of switch log entries reaches 1000, the oldest 100 log entries will first be copied from the switch to the ABC-02 before they are over written.</p> <p>Enable the Automatically backup the event log to prevent it being overwritten option, and then click Apply. After that, when the ABC-02 is plugged into the switch, the event logs will always be saved to the ABC-02 automatically when the number of switch log entries reaches 1000. Each backup action saves the oldest 100 logs to the ABC-02 in one file, with the filename generated by the current system time as MMDDHHmm.log. The file is saved to the His_log folder.</p> <p>NOTE: MM=month, DD=day, HH=hour, mm=minutes, from the system time.</p>	unchecked

NOTE: Press **Apply** once to activate the automatic backup function. Be sure an ABC-02 has been attached to the Moxa industrial smart Ethernet switch’s USB storage port before activating the function.

The following information is included in a log file:

Index	An event index assigned to identify the event sequence.
Bootup Number	This field shows how many times the Moxa switch has been rebooted or cold started.
Date	The date is updated based on how the current date is set on the System Settings page.
Time	The time is updated based on how the current time is set on the System Settings page.
System Startup Time	The system startup time related to this event.
Event	Events that have occurred.

Configuration Backup and Restore Instructions

The configuration backup and restore settings page has three main sections. The first section is used to manually select the destination for backing up and restoring the configuration, the second section is used to set the password for encrypting the downloaded configuration files, and the third section is used to activate automatically restoring the configuration file from an attached ABC-02 when the switch is booted up and backing up the configuration automatically to the attached ABC-02 whenever there is any change.

Configuration Backup and Restore

Local
 TFTP Server
 Auto Backup Configurator (ABC-02)

Backup Configuration File to Local Computer **Backup**

Restore Configuration From **Browse**
Restore

Configuration File Encryption Setting

Enable Password **Apply**

Automatically load configurations from ABC-02 to the system when booting up
 Automatically backup to ABC-02 when configurations change

Apply

Configuration Backup and Restore

Setting	Description	Factory Default
Local	<ol style="list-style-type: none"> 1. Select Local and click the Backup button to back up the configuration file (the file will be named Sys.ini) to a local drive. 2. Click Browse to search for a configuration on a local disk, and then click the Restore button. 	Local
TFTP Server	<ol style="list-style-type: none"> 1. Select TFTP Server and enter the TFTP server's IP address. 2. Input the backup/restore file name (supports up to 54 characters, including the .ini file extension) and then click the Backup/Restore button. 	
Auto Backup Configurator (ABC-02)	<ol style="list-style-type: none"> 1. Click Backup to save the configuration file to the ABC-02. The file will be saved in the ABC-02's Moxa folder as a *.ini file (e.g., Sys.ini). 2. Click Browse to select the configuration file, and then click Restore to start loading the configuration into the switch. <p style="font-size: small; margin-top: 10px;">NOTE: two files will be saved to the ABC-02-USB's Moxa folder: Sys.ini and MAC.ini. The purpose of saving the two files is to identify which file will be used when Auto load configuration from ABC to system when boot up is activated. MAC.ini is named using the last 6 digits of the switch's MAC address, without spaces.</p>	

NOTE: Select the method you would like to use and then press **Backup** to start the backup operation.

Configuration File Encryption Setting

Setting	Description	Factory Default
Enable Password	<ol style="list-style-type: none"> In order to back up an encrypted configuration file from a smart switch, select the checkbox and type in a password to enable encrypting the configuration file when it is downloaded. When loading the encrypted configuration file into a smart switch, first enable the function and type in the corresponding password to decrypt the configuration file while it is being loaded. 	unchecked

Automatically Load and Restore the Configuration

Setting	Description	Factory Default
Automatically load configurations from the ABC-02 to the system when booting up	<ol style="list-style-type: none"> Enable this function by selecting the Automatically load configurations from ABC-02 to the system when booting up checkbox and then click Apply. Power off your switch first, and then plug in the ABC-02. When you power on your switch, the system will detect the configuration file on the ABC-02 automatically. The switch will recognize the file name, with the following sequence priority: <ul style="list-style-type: none"> First priority: MAC.ini Second priority: Sys.ini If no matching configuration file is found, the fault LED light will turn on, and the switch will boot up normally. NOTE: The MAC.ini configuration file should be named using the last 6 digits of the switch's MAC address, without spaces. 	Checked
Automatically backup to ABC-02 when configurations change	<ol style="list-style-type: none"> Enable this function by checking the Automatically backup to ABC-02 when configurations change checkbox and then click Apply. Attach a Moxa ABC-02 for backing up the switch configuration files automatically. Once the current configuration is modified, the switch will back up the modified configuration to the /His_ini folder on the ABC-02. The file name will be the system date/time (MMDDHHmm.ini). NOTE: MM=month, DD=day, HH=hour, mm=minutes, from the system time.	unchecked

Firmware Upgrade Instructions

There are three ways to update the Moxa industrial smart Ethernet switch's firmware: from a local *.rom file, by remote TFTP server, and with Auto Backup Configurator (ABC-02).

Local

1. Download the updated firmware (*.rom) file from Moxa's website (www.moxa.com).
2. Click **Browse** to locate the (*.rom) file, and then click the **Upgrade** button.

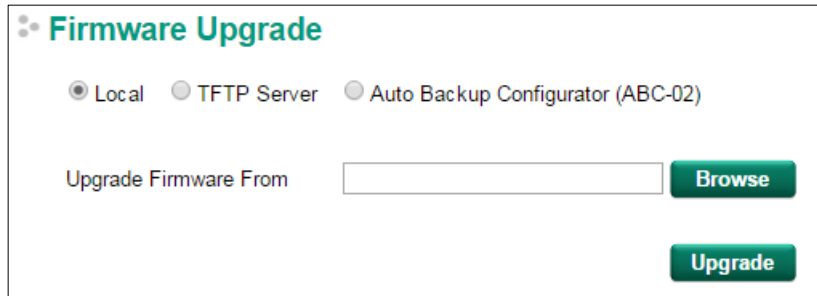

The screenshot shows the 'Firmware Upgrade' section of a web interface. At the top, there are three radio buttons: 'Local' (selected), 'TFTP Server', and 'Auto Backup Configurator (ABC-02)'. Below the radio buttons, there is a text input field labeled 'Upgrade Firmware From' and a green 'Browse' button to its right. Below the input field, there is a green 'Upgrade' button.

TFTP Server

1. Enter the TFTP server's IP address.
2. Input the firmware file name (*.rom) and click the **Upgrade** button.

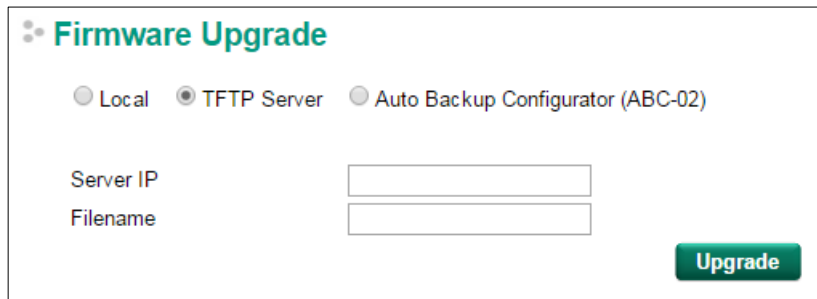

The screenshot shows the 'Firmware Upgrade' section of a web interface. At the top, there are three radio buttons: 'Local', 'TFTP Server' (selected), and 'Auto Backup Configurator (ABC-02)'. Below the radio buttons, there are two text input fields: 'Server IP' and 'Filename'. To the right of the 'Filename' field is a green 'Upgrade' button.

Auto Backup Configurator (ABC-02)

1. Download the updated firmware (*.rom) file from Moxa's website (www.moxa.com).
2. Save the file to the ABC-02's **Moxa** folder. The filename cannot be longer than 8 characters, and the file extension must be .rom.
3. Browse for the firmware (*.rom) file from the ABC-02, and then click the **Upgrade** button.

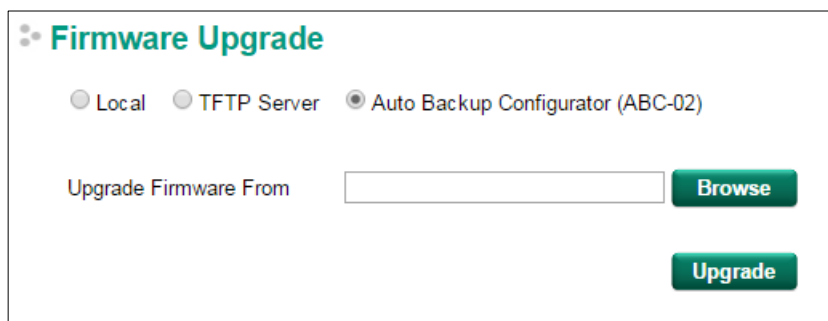

The screenshot shows the 'Firmware Upgrade' section of a web interface. At the top, there are three radio buttons: 'Local', 'TFTP Server', and 'Auto Backup Configurator (ABC-02)' (selected). Below the radio buttons, there is a text input field labeled 'Upgrade Firmware From' and a green 'Browse' button to its right. Below the input field, there is a green 'Upgrade' button.

User Account Instructions

The Moxa industrial smart Ethernet switch supports the management of accounts, including establishing, activating, modifying, disabling, and removing accounts. There are two levels of configuration access: **admin** and **user**. Accounts with **admin** privilege have read/write access of all configuration parameters, whereas accounts with **user** privilege only have read access to view configuration items.

- NOTE**
1. In order to maintain a higher level of security, we strongly suggest that you change the password after first login in.
 2. By default, there will be an "admin" user account with **admin** privilege and a "user" user account with **user** privilege. The accounts can be deleted or disabled but at least one account with admin privilege activated must be maintained at all times.
 3. You can create up to a maximum of 10 accounts.

The **User Account** settings page is divided into a top section and a bottom section. To modify the settings of a particular account, click the username for the account in the bottom section to highlight the line associated with the account, and then change the settings for the account in the top section of the page.

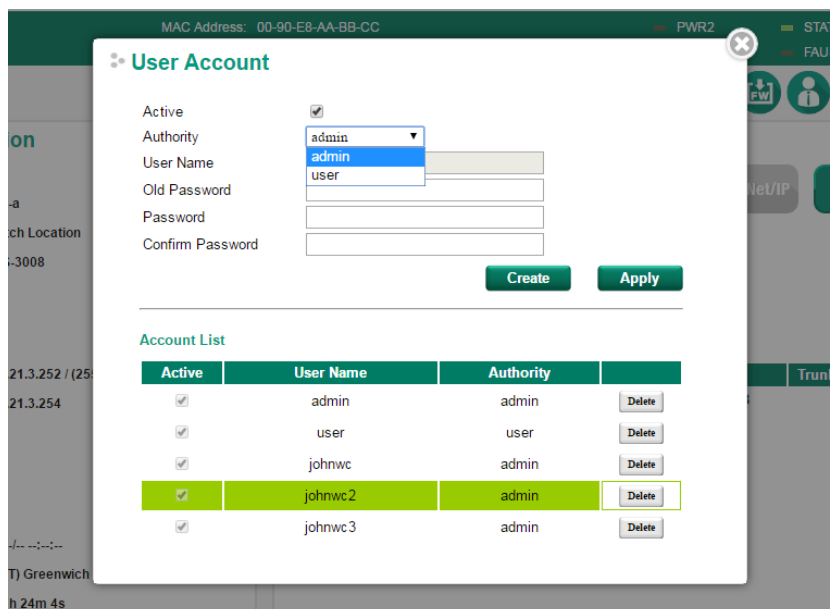

Creating a New Account

Type in the user name and password, assign an authority to the new account, and then click **Create**.

Setting	Description	Factory Default
Active	Check the Active checkbox to activate the account; uncheck the checkbox to deactivate the account.	checked
Authority	Select admin to assign read/write access to this account; the user will be able to configure all parameters. Select user to assign read-only access to this account; the user will only be able to view configuration parameters.	admin
User Name (Max. of 30 characters)	User Name	None
Password	Password for the user account (between 4 and 16 characters)	None
Confirm Password	Re-type in the password to further confirm the setting.	None

NOTE: The naming rule stipulated by SNMPv3 and industrial protocols requires passwords to be more than 8 characters in length; spaces are not allowed.

Modifying an Existing Account

Select an existing account from the Account List table, modify the account details (authority, user name, password, etc.), and then click **Apply** to save the changes.

User Account

Active

Authority

User Name

Old Password

Password

Confirm Password

Account List

Active	User Name	Authority	
<input checked="" type="checkbox"/>	admin	admin	<input type="button" value="Delete"/>
<input type="checkbox"/>	user	user	<input type="button" value="Delete"/>

Activate or Deactivate an Existing Account

Select an existing account from the Account List table, check or uncheck the **Active** check box, and then click **Apply** to save the changes.

User Account

Active

Authority

User Name

Old Password

Password

Confirm Password

Account List

Active	User Name	Authority	
<input checked="" type="checkbox"/>	admin	admin	<input type="button" value="Delete"/>
<input checked="" type="checkbox"/>	user	user	<input type="button" value="Delete"/>
<input checked="" type="checkbox"/>	test	admin	<input type="button" value="Delete"/>

Deleting an Existing Account

Click **Delete** to delete the account.

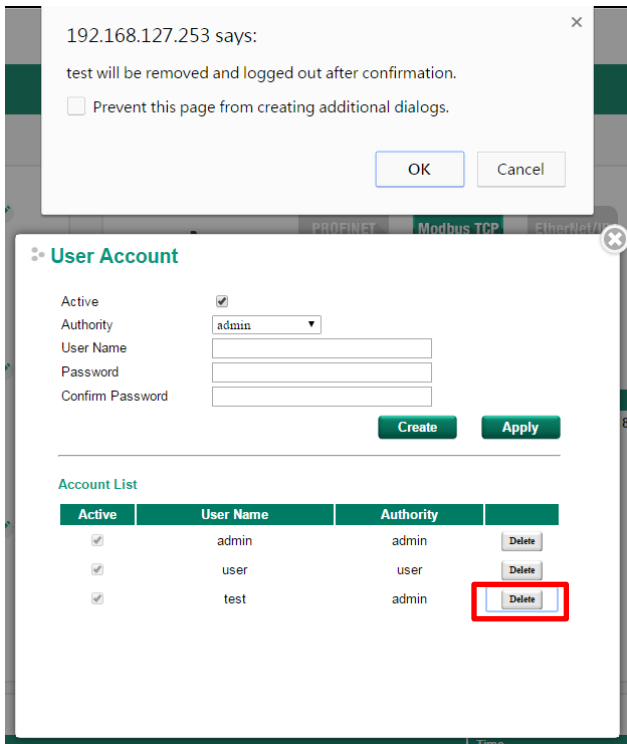

Management Functions

In this chapter, we explain in detail the management functions supported by Moxa's industrial smart Ethernet switch. The configuration and operating results are summarized on the switch's configuration information dashboard for quick reference. You can also use the "edit" icon to edit and adjust the settings to fit the needs of your application or network.

The following topics are covered in this chapter:

❑ **Switch Information**

- System Information
- Network Information
- Date and Time Information

❑ **Switch Panel and Profile**

- Switch Panel and Statistics
- Industrial Protocols and SNMP Settings
- Port Settings
- RSTP Settings
- VLAN Settings

❑ **Switch Log**

- Switch Log Table
- Warning Notification Settings

Switch Information

Switch Information is listed on the left side of the switch's configuration information dashboard. The following settings are shown:

1. System Information
2. Network Information
3. Date and Time Information

Click the **Edit** button to the right of the item you would like to edit.

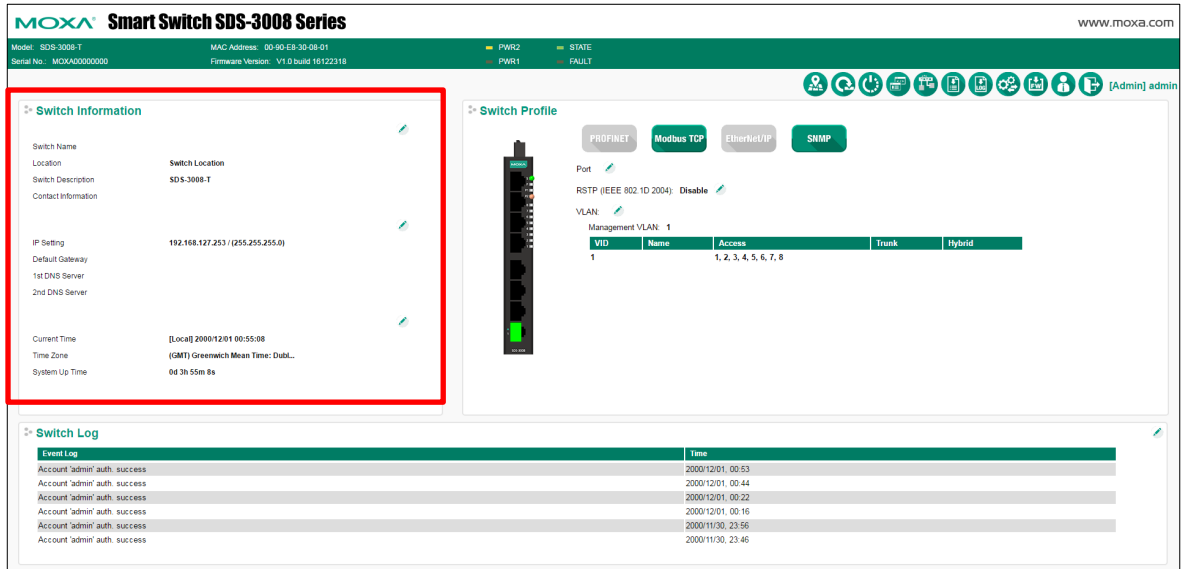

System Information

The following configuration page will pop up when you click the **Edit** button for the Switch Information Settings section. You can edit the Switch Name, Switch Location, etc.

System Information

Switch Name:

Switch Location:

Switch Description: SDS-3008-T

Contact Information:

Web Login Message:

Login Authentication Failure Message:

15 characters / Maximum 255 characters

0 characters / Maximum 240 characters

0 characters / Maximum 240 characters

Apply

Switch Name

Setting	Description	Factory Default
Max. 30 characters	This option is useful for differentiating between the roles or applications of different units. Example: Factory Switch 1.	none

NOTE The Switch Name field follows the PROFINET I/O naming rule. The name can only include these characters: **a-z/A-Z/0-9/-/./**, and the name cannot start with **port-xyz** or **port-xyz-abcde** where xyzabcde=0, 1, ..., 9 or is in the form n.n.n.n where n=0, 1, ..., 9

Switch Location

Setting	Description	Factory Default
Max. 255 characters	This option is useful for differentiating between the locations of different switches. Example: production line 1.	Switch Location

Switch Description

Setting	Description	Factory Default
Max. 30 characters	This option is useful for recording a more detailed descriptions of the unit.	Switch Model Name

Contact Information

Setting	Description	Factory Default
Max. 30 characters	This option is useful for providing information about who is responsible for maintaining this unit and how to contact this person.	None

Web Login Message

Setting	Description	Factory Default
Max. 240 characters	This option is useful as it shows a message when a user's login is successful	None

Login Authentication Failure Message

Setting	Description	Factory Default
Max. 240 characters	This option is useful as it shows a message when a user's login has failed	None

Network Information

Click the **IP Settings** edit icon to update the network settings.



The configuration page shown below will pop up. The switch supports both IPv4 and IPv6, and can be managed through either of these address types.

The IPv4 settings include the switch’s IP address and subnet mask, as well as the IP address of the default gateway. In addition, input cells are provided for the IP addresses of a 1st and 2nd DNS server.

The IPv6 settings include two distinct address types—Link-Local Unicast addresses and Global Unicast addresses. A Link-Local address makes the switch accessible over IPv6 for all devices attached to the same local subnet. To connect to a larger network with multiple segments, the switch must be configured with a Global Unicast address.

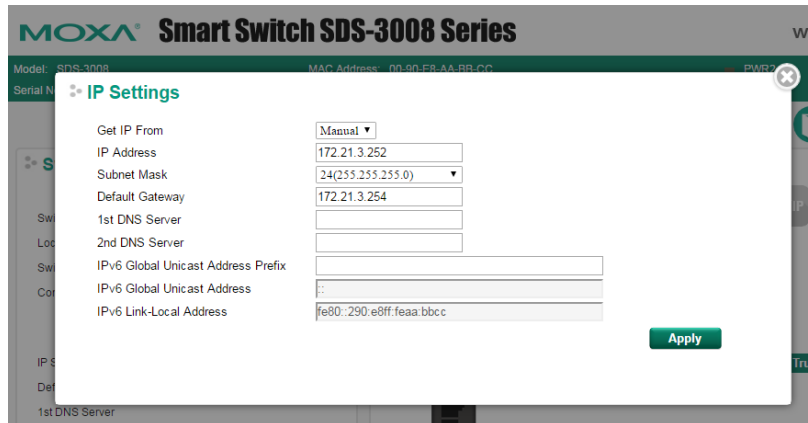

NOTE If the Moxa industrial smart Ethernet switch is configured for other VLAN settings, make sure the PC host is connected to the same management VLAN (default is 1) that the Moxa smart switch is connected to.

Get IP From

Setting	Description	Factory Default
Manual	The Moxa switch’s IP address must be set manually.	Manual
DHCP	The Moxa switch’s IP address will be assigned automatically by the network’s DHCP server.	
BOOTP	The Moxa switch’s IP address will be assigned automatically by the network’s BootP server.	

IP Address

Setting	Description	Factory Default
IP address for the Moxa switch	Assigns the Moxa switch’s IP address on a TCP/IP network.	192.168.127.253

Subnet Mask

Setting	Description	Factory Default
Subnet mask for the Moxa switch	Identifies the type of network the Moxa switch is connected to (e.g., 255.255.0.0 for a Class B network, or 255.255.255.0 for a Class C network).	24 (255.255.255.0)

Default Gateway

Setting	Description	Factory Default
IP address for gateway	Specifies the IP address of the router that connects the LAN to an outside network.	None

DNS Server IP Addresses

Setting	Description	Factory Default
1st DNS Server	Specifies the IP address of the DNS server used by your network. After specifying the DNS server’s IP address, you can use the Moxa switch’s URL (e.g., www.PT.company.com) to open the web console instead of entering the IP address.	None
2nd DNS Server	Specifies the IP address of the secondary DNS server used by your network. The Moxa switch will use the secondary DNS server if the first DNS server fails to connect.	None

IPv6 Global Unicast Address Prefix (Prefix Length: 64 bits) Default Gateway

Setting	Description	Factory Default
Global Unicast Address Prefix	The prefix value must be formatted according to the RFC 2373 "IPv6 Addressing Architecture," using 8 colon-separated 16-bit hexadecimal values. One double colon may be used in the address to indicate the appropriate number of zeros required to fill the undefined fields.	None

IPv6 Global Unicast Address

Setting	Description	Factory Default
None	Displays the IPv6 Global Unicast address. The network portion of the Global Unicast address can be configured by specifying the Global Unicast Prefix and using an EUI-64 interface ID in the low order 64 bits. The host portion of the Global Unicast address is automatically generated using the modified EUI-64 form of the interface identifier (Switch's MAC address).	None

IPv6 Link-Local Address

Setting	Description	Factory Default
None	The network portion of the Link-Local address is FE80 and the host portion of the Link-Local address is automatically generated using the modified EUI-64 form of the interface identifier (Switch's MAC address).	None

Date and Time Information

The following page will pop up when you click the Switch Information System Time Settings **Edit** button. You can configure the System Up Time, Current Time, etc.

The Moxa industrial smart Ethernet switch also has a time calibration function based on information from an NTP/SNTP server or user-specified time and date, allowing functions such as log and trap to include a time and date stamp.

System Time
Refresh

System Up Time: 0d 0h 37m 46s

Current Time: 2000/11/30 00:37:46

Time Zone: (GMT) Greenwich Mean Time: Dublin, Edinburgh, Lisbon, London ▼

Daylight Saving

Daylight Saving	Month	Week	Day	Hour
Start Date	-- ▼	-- ▼	-- ▼	-- ▼
End Date	-- ▼	-- ▼	-- ▼	-- ▼
Offset (hr.)	0 ▼			

Clock Source

Local
 NTP
 SNTP

Time Settings

Manual Time Settings

Date (YYYY/MM/DD): / /

Time (HH:MM:SS): : :

Sync from Local Device Time 2016/12/27 20:28:24

NTP/SNTP Server Settings

Enable NTP/SNTP Server

Apply

System Time

System Up Time

Indicates how long the Moxa smart switch has been up and running since the last cold start.

Current Time

Setting	Description	Factory Default
User-specified time	Indicates time in yyyy-mm-dd format.	None

Time Zone

Setting	Description	Factory Default
Time zone	Specifies the time zone, which is used to determine the local time offset from GMT (Greenwich Mean Time).	GMT (Greenwich Mean Time)

NOTE Changing the time zone will automatically correct the current time. Be sure to set the time zone before setting the time.

Daylight Saving Time

The Daylight Saving Time settings are used to automatically set the Moxa smart switch's time ahead according to national standards.

Start Date

Setting	Description	Factory Default
User-specified date	Specifies the date that Daylight Saving Time begins.	None

End Date

Setting	Description	Factory Default
User-specified date	Specifies the date that Daylight Saving Time ends.	None

Offset

Setting	Description	Factory Default
User-specified hour	Specifies the number of hours that the time should be set forward during Daylight Saving Time.	None

Clock Source

Setting	Description	Factory Default
Local	Configure clock source from local time	Local
NTP	Configure clock source from NTP	
SNTP	Configure clock source from SNTP	

Clock Source is from Local

Clock Source Local NTP SNTP

Time Settings

Manual Time Settings

Date (YYYY/MM/DD) / /

Time (HH:MM:SS) : :

Sync. from Local Device Time 2016/7/2 14:21:20

Time Settings

You can set the smart switch’s date and time manually by selecting the **Manual Time Settings** option. Type in the corresponding Date and Time or sync automatically from a local host (local device) connected to the smart switch.

Clock Source is from NTP

The Moxa smart switch can work as an NTP client. You can enable the NTP Authentication function to authenticate between the NTP client and NTP server using a configured Authentication Key.

Clock Source Local NTP SNTP

NTP Authentication Settings

Enable NTP Authentication

Authentication Key ▼

Key ID	Type	Key String	Trusted
<input type="text"/>	MD5	<input type="text"/>	<input type="checkbox"/>
<input type="text"/>	MD5	<input type="text"/>	<input type="checkbox"/>
<input type="text"/>	MD5	<input type="text"/>	<input type="checkbox"/>
<input type="text"/>	MD5	<input type="text"/>	<input type="checkbox"/>
<input type="text"/>	MD5	<input type="text"/>	<input type="checkbox"/>

Note: Key ID - Authentication key for trusted time sources (1~65535)

NTP Client Settings

Index	Time Server/Peer Address	Authentication
1	time.nist.gov	<input type="checkbox"/> <input style="background-color: #cccccc;" type="text"/>
2	<input type="text"/>	<input type="checkbox"/> <input style="background-color: #cccccc;" type="text"/>

NTP Authentication Settings

Setting	Description	Factory Default
Checked	Enable NTP Authentication	Unchecked
Unchecked	Disable NTP Authentication	

Authentication Key

You can configure up to five Authentication Keys in Moxa smart switch’s database. The Keys are encrypted by type MD5 and authorized between the NTP server and the NTP client.

Key ID

Setting	Description	Factory Default
Key ID	ID of the Authentication Key	Unchecked

Key String

Setting	Description	Factory Default
Key String	Password of the Authentication Key	Unchecked

Trusted

Setting	Description	Factory Default
Checked	Enable the Authentication Key	Unchecked
Unchecked	Disable the Authentication Key	

NTP Client Settings

The NTP server should be set when the Moxa smart switch is configured to work as an NTP client.

Setting	Description	Factory Default
Time Server/Peer Address	The domain of Time Server or Peer Address	time.nist.gov

Authentication

Setting	Description	Factory Default
Checked	Enable NTP Authentication	Unchecked
Unchecked	Disable NTP Authentication	
Key ID	The Key ID used for authorization	Null

Clock Source is from SNTP

Clock Source Local NTP SNTP

SNTP Client Settings

1st Time Server

2nd Time Server

Query Period secs

SNTP Client Settings

Setting	Description	Factory Default
1st Time Server	The IP or domain address (e.g., 192.168.1.1, time.stdtime.gov.tw, or time.nist.gov).	Time.nist.gov
2nd Time Server	The Moxa smart switch will try to locate the secondary SNTP server if the first SNTP server fails to connect.	
Query Period	The time period to sync with the time server	600 sec.

NOTE Changing the time zone will automatically correct the current time. Be sure to set the time zone before setting the time.

NTP/SNTP Server Settings

The Moxa switch can work as an NTP server. The NTP server checkbox should be enabled when the Moxa smart switch will be used as an NTP server.

NTP/SNTP Server Settings

Enable NTP/SNTP Server

[Apply](#)

Enable NTP/SNTP Server

Setting	Description	Factory Default
Enable/Disable	Enables SNTP/NTP server functionality for clients	Disabled

Switch Panel and Profile

The Switch Profile panel is located on the right side of the switch’s configuration information dashboard. The panel indicates the current status of the following items:

1. Port status and TX/RX Statistics (shown on switch panel diagram)
2. Industrial Protocols and SNMP
3. RSTP redundancy
4. VLAN

Click a **Protocol** button to activate or deactivate a protocol, and click the **Edit** button if you need to modify the settings.

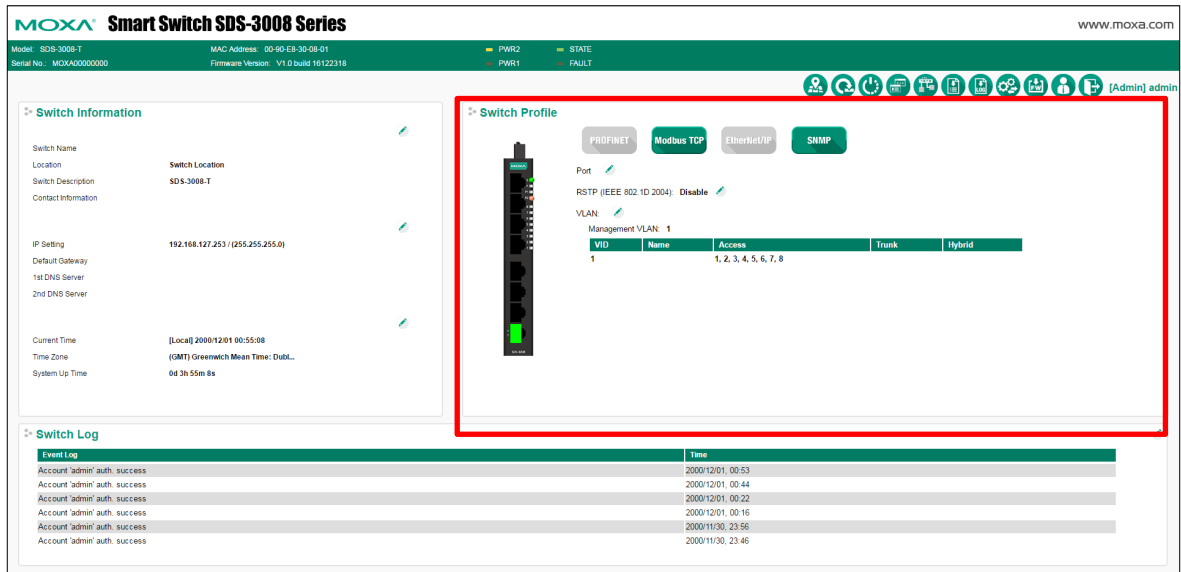

Switch Panel and Statistics

The image of the front panel of the smart switch shown on the dashboard can be used to view the switch’s current operational information. When you pass the mouse over a port on the panel, a table summarizing the port’s current TX/RX statistics will pop up. The example below shows the status of port 1.

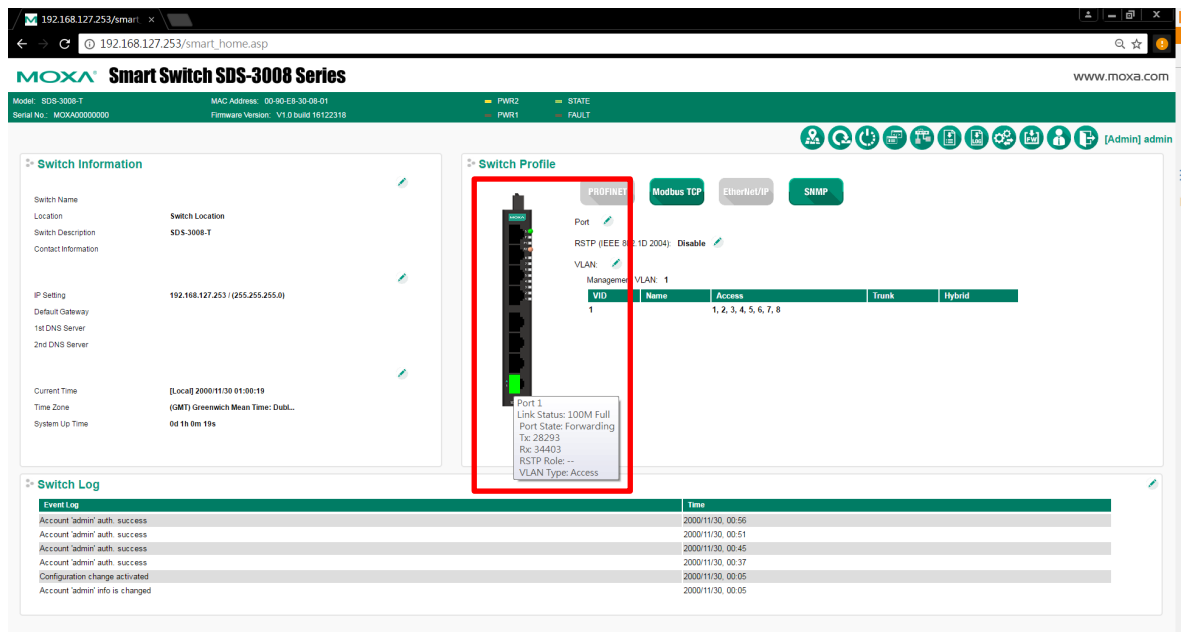

The following is shown in the summary table:

Port Number Index	The port number
Link Status	The current connection speed and duplex mode of the port
Port State	The link state of the port; there are several states, including Disable, Blocking, Listening, Learning, and Forwarding
TX	The TX transmission speed (packets per second)
RX	The RX transmission speed (packets per second)
RSTP Role	The RSTP role of the port; there are several states, including Unknown, Alternate, Root, Designated, and Backup
VLAN Type	An index to show you the VLAN port type setting on the specific port; there are three type of the VLAN port type: Access (Default), Trunk, and Hybrid.

Industrial Protocols and SNMP Settings

Click an industrial protocol button or the SNMP profile button (as shown in following diagram) to activate the protocol. The protocol will operate based on the protocol’s default settings, which can be modified if needed.

NOTE All four protocol profiles can be enabled or disabled by clicking the corresponding button. Modbus TCP and SNMP are enabled by default (indicated by green), with the other two protocols disabled (indicated by gray). When a certain profile is enabled, some of the managed functions and corresponding parameters will be activated and set automatically; e.g., QoS for cycling data, IGMP snooping, etc.

NOTE When the smart switch is used with Rockwell systems that support multicast Implicit (I/O) Messaging, to ensure efficient EtherNet/IP transmissions, the smart switch will be enabled automatically for IGMP Snooping and IGMP Query.

NOTE SNMP may need further settings. Click the **SNMP** button to open the settings page.

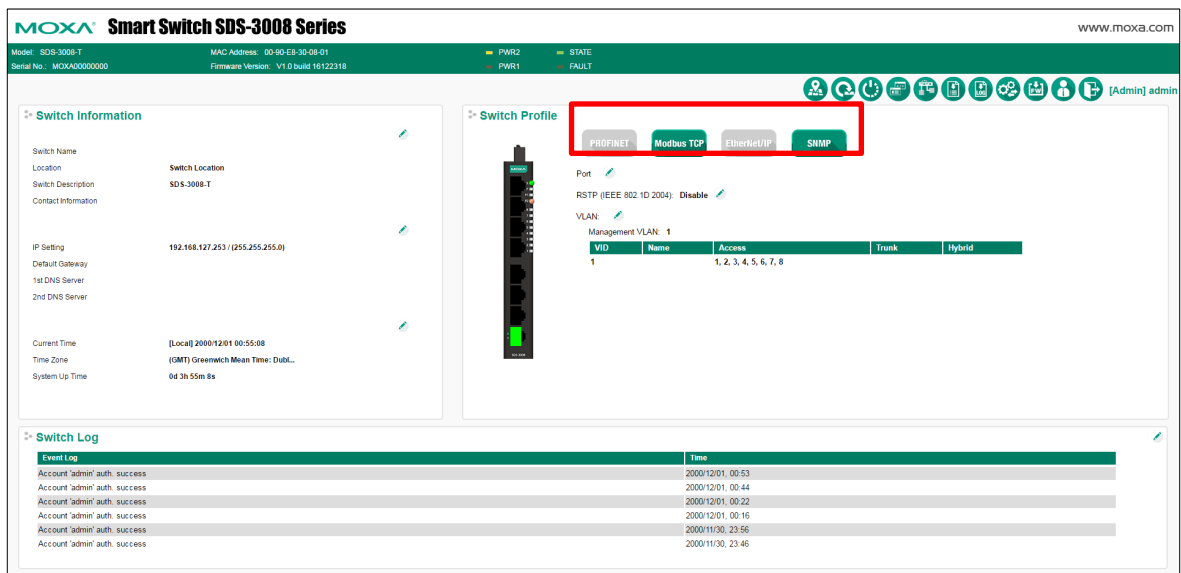

Industrial Protocol and SNMP profiles

Setting	Description	Factory Default																																																
PROFINET	<p>1. Click the PROFINET button to enable the Moxa smart switch to perform as a PROFINET I/O device (conformance class A). A comprehensive set of PROFINET I/O attributes (sent via cyclic or acyclic I/O data) are available for more flexible setup and monitoring. To integrate the switch into PROFINET-based HMI/SCADA and PLC (programmable logic controller) systems, you may also need the switch’s GSD (General Station Description) file and product image, which you can download from the Moxa industrial smart Ethernet switch product page: http://www.moxa.com/product/SDS-3008.htm</p> <p>2. When PROFINET is enabled, a bundle of PROFINET cyclic I/O data will be sent between the PLC and switch periodically (default period = 128 ms). The data is transmitted in near real time, allowing the PLC to check the health and availability of the switch. The following PROFINET cyclic I/O data are provided:</p> <table border="1"> <thead> <tr> <th>Category</th> <th>Direction</th> <th>Byte</th> <th>Bit</th> <th>Name</th> <th>Description</th> </tr> </thead> <tbody> <tr> <td rowspan="4">Device</td> <td rowspan="4">Input</td> <td rowspan="4">0</td> <td>0</td> <td>Device status</td> <td>0: failed 1: OK</td> </tr> <tr> <td>1</td> <td>Power 1</td> <td>0: unavailable 1: OK</td> </tr> <tr> <td>2</td> <td>Power 2</td> <td>0: unavailable 1: OK</td> </tr> <tr> <td>3</td> <td>RSTP status</td> <td>0: disabled 1: enabled</td> </tr> <tr> <td rowspan="8">Port</td> <td rowspan="8">Input</td> <td rowspan="8">1</td> <td>0</td> <td>Port 1 Connection</td> <td>0: not connected 1: connected</td> </tr> <tr> <td>1</td> <td>Port 2 Connection</td> <td>0: not connected 1: connected</td> </tr> <tr> <td>2</td> <td>Port 3 Connection</td> <td>0: not connected 1: connected</td> </tr> <tr> <td>3</td> <td>Port 4 Connection</td> <td>0: not connected 1: connected</td> </tr> <tr> <td>4</td> <td>Port 5 Connection</td> <td>0: not connected 1: connected</td> </tr> <tr> <td>5</td> <td>Port 6 Connection</td> <td>0: not connected 1: connected</td> </tr> <tr> <td>6</td> <td>Port 7 Connection</td> <td>0: not connected 1: connected</td> </tr> <tr> <td>7</td> <td>Port 8 Connection</td> <td>0: not connected 1: connected</td> </tr> </tbody> </table> <p>The Moxa smart switch supports several PROFINET I/O parameters for greater flexibility. These PROFINET I/O parameters use PROFINET acyclic I/O data to achieve communication on the PROFINET network and control PROFINET alarm functions. The PROFINET alarm is a message sent from the switch to the PLC immediately when the corresponding event occurs. These parameters are readable or writable, and users can use the SIMATIC STEP 7 tool or engineering deployment software to edit the parameters and set up the alarm. For details about the Moxa switch’s support for PROFINET and a list of PROFINET I/O parameters that are supported, see the Moxa Industrial Protocols User’s Guide at http://www.moxa.com/product/SDS-3008.htm</p> <p>NOTE: The transfer frequency of the PROFINET Cyclic I/O data on the Moxa industrial smart Ethernet switch is fixed at 128 ms.</p>	Category	Direction	Byte	Bit	Name	Description	Device	Input	0	0	Device status	0: failed 1: OK	1	Power 1	0: unavailable 1: OK	2	Power 2	0: unavailable 1: OK	3	RSTP status	0: disabled 1: enabled	Port	Input	1	0	Port 1 Connection	0: not connected 1: connected	1	Port 2 Connection	0: not connected 1: connected	2	Port 3 Connection	0: not connected 1: connected	3	Port 4 Connection	0: not connected 1: connected	4	Port 5 Connection	0: not connected 1: connected	5	Port 6 Connection	0: not connected 1: connected	6	Port 7 Connection	0: not connected 1: connected	7	Port 8 Connection	0: not connected 1: connected	unchecked
Category	Direction	Byte	Bit	Name	Description																																													
Device	Input	0	0	Device status	0: failed 1: OK																																													
			1	Power 1	0: unavailable 1: OK																																													
			2	Power 2	0: unavailable 1: OK																																													
			3	RSTP status	0: disabled 1: enabled																																													
Port	Input	1	0	Port 1 Connection	0: not connected 1: connected																																													
			1	Port 2 Connection	0: not connected 1: connected																																													
			2	Port 3 Connection	0: not connected 1: connected																																													
			3	Port 4 Connection	0: not connected 1: connected																																													
			4	Port 5 Connection	0: not connected 1: connected																																													
			5	Port 6 Connection	0: not connected 1: connected																																													
			6	Port 7 Connection	0: not connected 1: connected																																													
			7	Port 8 Connection	0: not connected 1: connected																																													

<p>Modbus TCP</p>	<ol style="list-style-type: none"> 1. Click the Modbus TCP button to enable the Modbus TCP protocol on the Moxa smart switch. The Modbus TCP protocol can be used to integrate the smart switch with Modbus TCP-based HMI/SCADA systems. 2. The Modbus TCP protocol is commonly used to integrate a SCADA system. It is also a vendor neutral communication protocol used to monitor and control industrial automation equipment such as PLCs, sensors, and meters. In order to be fully integrated into industrial systems, Moxa’s industrial smart Ethernet switches support the Modbus TCP protocol profile to provide users with a quick way to set up and integrate the switch with HMI or SCADA systems for better monitoring. Once the Modbus TCP profile is enabled, data can be read using the following data access types: Function code 4 with 16-bit (2-word) data access, or read only. The types of data that can be read includes system information, port information, packet information, redundancy information, etc. For more details regarding the Moxa industrial smart Ethernet switch’s support of Modbus TCP and the Modbus TCP data mapping, see the Moxa Industrial Protocols User’s Guide at http://www.moxa.com/product/SDS-3008.htm) 	<p>checked</p>
<p>EtherNet/IP</p>	<ol style="list-style-type: none"> 1. Click the EtherNet/IP button to enable the Moxa smart switch to perform as an Ethernet/IP device (adapter class). A comprehensive set of objects and corresponding attributes and services (sent via explicit messaging or implicit messaging) are available for flexible setup and monitoring. To integrate the switch into Ethernet/IP-based HMI/SCADA and PLC (programmable logic controller) systems, you may also need the switch’s EDS (Electronic Data Sheet) file, AOI (Add-on Instruction) file, and the product image, which you can download from the Moxa smart switch product page: http://www.moxa.com/product/SDS-3008.htm 2. Several CIP (Common Industrial Protocol) communication objects are defined. Moxa’s smart switches support the following objects for monitoring PLCs and HMI/SCADA systems: <ul style="list-style-type: none"> • Identity Object • TCP/IP Interface Object • Ethernet Link Object • Assembly Object • Message Router Object • Connection Manager Object • Port Object • Moxa Networking Object (Vendor Specific) For more details regarding the supported attributes and services of the above objects and the access rules for each attribute, see the Moxa Industrial Protocols User’s Guide at: http://www.moxa.com/product/SDS-3008.htm <p>NOTE: If you need to integrate the smart switch with an EtherNet/IP network for I/O operations, then IGMP Snooping and IGMP Query may be needed; when you click the EtherNet/IP button, the smart switch enables IGMP Snooping and IGMP Query automatically.</p>	<p>unchecked</p>

SNMP	<p>1. Click the SNMP button to enable SNMP and related settings.</p> <p>2. The Moxa smart switch supports SNMP V1, V2c, and V3. SNMP V1 and SNMP V2c use a community string match for authentication, which means that SNMP servers access all objects with read-only or read/write permissions using the community strings public and private by default. SNMP V3, which is the most secure protocol, requires that you select an authentication level of MD5 or SHA. You can also enable data encryption to enhance data security. SNMP security modes and levels that are supported are shown in the following table. Select the security mode and level that will be used to communicate between the SNMP agent and manager.</p>				checked																										
<table border="1"> <thead> <tr> <th>Protocol Version</th> <th>UI Setting</th> <th>Authentication</th> <th>Encryption</th> <th>Method</th> </tr> </thead> <tbody> <tr> <td rowspan="2">SNMP V1, V2c</td> <td>V1, V2c Read Community</td> <td>Community string</td> <td>No</td> <td>Uses a community string match for authentication.</td> </tr> <tr> <td>V1, V2c Write/Read Community</td> <td>Community string</td> <td>No</td> <td>Uses a community string match for authentication.</td> </tr> <tr> <td rowspan="3">SNMP V3</td> <td>No-Auth</td> <td>No</td> <td>No</td> <td>Uses an account with admin or user to access objects</td> </tr> <tr> <td>MD5 or SHA</td> <td>Authentication based on MD5 or SHA</td> <td>No</td> <td>Provides authentication based on HMAC-MD5, or HMAC-SHA algorithms. 8-character passwords are the minimum requirement for authentication.</td> </tr> <tr> <td>MD5 or SHA</td> <td>Authentication based on MD5 or SHA</td> <td>Data encryption key</td> <td>Provides authentication based on HMAC-MD5 or HMAC-SHA algorithms, and data encryption key. 8-character passwords and a data encryption key are the minimum requirements for authentication .and encryption.</td> </tr> </tbody> </table>					Protocol Version	UI Setting	Authentication	Encryption	Method	SNMP V1, V2c	V1, V2c Read Community	Community string	No	Uses a community string match for authentication.	V1, V2c Write/Read Community	Community string	No	Uses a community string match for authentication.	SNMP V3	No-Auth	No	No	Uses an account with admin or user to access objects	MD5 or SHA	Authentication based on MD5 or SHA	No	Provides authentication based on HMAC-MD5, or HMAC-SHA algorithms. 8-character passwords are the minimum requirement for authentication.	MD5 or SHA	Authentication based on MD5 or SHA	Data encryption key	Provides authentication based on HMAC-MD5 or HMAC-SHA algorithms, and data encryption key. 8-character passwords and a data encryption key are the minimum requirements for authentication .and encryption.
Protocol Version	UI Setting	Authentication	Encryption	Method																											
SNMP V1, V2c	V1, V2c Read Community	Community string	No	Uses a community string match for authentication.																											
	V1, V2c Write/Read Community	Community string	No	Uses a community string match for authentication.																											
SNMP V3	No-Auth	No	No	Uses an account with admin or user to access objects																											
	MD5 or SHA	Authentication based on MD5 or SHA	No	Provides authentication based on HMAC-MD5, or HMAC-SHA algorithms. 8-character passwords are the minimum requirement for authentication.																											
	MD5 or SHA	Authentication based on MD5 or SHA	Data encryption key	Provides authentication based on HMAC-MD5 or HMAC-SHA algorithms, and data encryption key. 8-character passwords and a data encryption key are the minimum requirements for authentication .and encryption.																											
<p>The above parameters can be configured on the SNMP page that pops up when you click the SNMP button.</p> <p>NOTE: The username and password of SNMP V3 are the same as the username and password of User Account. Accounts with admin privilege have read/write access to all configuration parameters. Accounts with user authority only have read access to configuration parameters.</p>																															

SNMP Settings

SNMP Settings

SNMP Settings

SNMP Enable

SNMP Versions

Admin Auth. Type

Enable Admin Data Encryption Data Encryption Key

User Auth. Type

Enable User Data Encryption Data Encryption Key

Community

V1,V2c Read Community

V1,V2c Write/Read Community

Trap/Inform Recipient

Mode

Host IP Address 1

1st Trap Community

Host IP Address 2

2nd Trap Community

SNMP Read/Write Settings

SNMP Versions

Setting	Description	Factory Default
V1, V2c, V3, or V1, V2c, or V3 only	Specifies the SNMP protocol version used to manage the switch.	V1, V2c

V1, V2c Read Community

Setting	Description	Factory Default
Max. 30 characters	Specifies the community string to authenticate the SNMP agent for read-only access. The SNMP agent will access all objects with read-only permissions using this community string.	Public

V1, V2c Write/Read Community

Setting	Description	Factory Default
Max. 30 characters	Specifies the community string to authenticate the SNMP agent for read/write access. The SNMP server will access all objects with read/write permissions using this community string.	Private

For SNMP V3, two levels of privilege are available for accessing the Moxa switch. **Admin** privilege provides access and authorization to read and write the MIB file. **User** privilege only allows reading the MIB file.

Admin Auth. Type (for SNMP V1, V2c, V3, and V3 only)

Setting	Description	Factory Default
No-Auth	Allows the admin account to access objects without authentication.	No
MD5-	Authentication will be based on the HMAC-MD5 algorithms.	No

Auth	8-character passwords are the minimum requirement for authentication.	
SHA-Auth	Authentication will be based on the HMAC-SHA algorithms. 8-character passwords are the minimum requirement for authentication.	No

Enable Admin Data Encryption Key (for SNMP V1, V2c, V3, and V3 only)

Setting	Description	Factory Default
Enable	Enables data encryption using the specified data encryption key (between 8 and 30 characters).	No
Disable	Specifies that data will not be encrypted.	No

User Auth. Type (for SNMP V1, V2c, V3 and V3 only)

Setting	Description	Factory Default
No-Auth	Allows the admin account and user account to access objects without authentication.	No
MD5-Auth	Authentication will be based on the HMAC-MD5 algorithms. 8-character passwords are the minimum requirement for authentication.	No
SHA-Auth	Authentication will be based on the HMAC-SHA algorithms. 8-character passwords are the minimum requirement for authentication.	No

Enable User Data Encryption Key (for SNMP V1, V2c, V3 and V3 only)

Setting	Description	Factory Default
Enable	Enables data encryption using the specified data encryption key (between 8 and 30 characters).	No
Disable	No data encryption	No

Trap Settings

SNMP traps allow an SNMP agent to notify the NMS of a significant event. The switch supports two SNMP modes: **Trap** mode and **Inform** mode.

Trap/inform Recipient

Trap Mode Trap V1 ▾

Host IP Address 1

1st Trap Community public

Host IP Address 2

2nd Trap Community public

SNMP Trap Mode—Trap

When Trap Mode is set to Trap, the SNMP agent sends an SNMPv1 trap PDU to the NMS. No acknowledgment is sent back from the NMS so the agent has no way of knowing if the trap reached the NMS.

SNMP Trap Mode—Inform

SNMPv2 supports an inform mechanism. When an inform message is sent from the SNMP agent to the NMS, the receiver sends a response to the sender acknowledging receipt of the event. This behavior is similar to that of the get and set requests. If the SNMP agent does not receive a response from the NMS for a period of time, the agent will resend the trap to the NMS agent. The maximum timeout time is 300 sec (default is 1 sec), and the maximum number of retries is 99 times (default is 1 time). When the SNMP agent receives acknowledgement from the NMS, it will stop resending the inform messages.

Host IP Address 1

Setting	Description	Factory Default
IP or name	Specifies the IP address or name of the primary trap server used by your network.	None

1st Trap Community

Setting	Description	Factory Default
Max. of 30 characters	Specifies the community string to use for authentication.	Public

Host IP Address 2

Setting	Description	Factory Default
IP or name	Specifies the IP address or name of the secondary trap server used by your network.	None

2nd Trap Community

Setting	Description	Factory Default
Max. of 30 characters	Specifies the community string to use for authentication.	Public

Port Settings

Click the Port **Edit** button in the Switch Panel. When the **Port Settings** page pops up, you can configure port access, port transmission speed, flow control, port type (MDI or MDIX), etc.

Port Settings

Port	Enable	Media Type	Description	Speed	Flow Control	MDI/MDIX
1	<input checked="" type="checkbox"/>	100TX, RJ45.		Auto ▼	Disable ▼	Auto ▼
2	<input checked="" type="checkbox"/>	100TX, RJ45.		Auto ▼	Disable ▼	Auto ▼
3	<input checked="" type="checkbox"/>	100TX, RJ45.		Auto ▼	Disable ▼	Auto ▼
4	<input checked="" type="checkbox"/>	100TX, RJ45.		Auto ▼	Disable ▼	Auto ▼
5	<input checked="" type="checkbox"/>	100TX, RJ45.		Auto ▼	Disable ▼	Auto ▼
6	<input checked="" type="checkbox"/>	100TX, RJ45.		Auto ▼	Disable ▼	Auto ▼
7	<input checked="" type="checkbox"/>	100TX, RJ45.		Auto ▼	Disable ▼	Auto ▼
8	<input checked="" type="checkbox"/>	100TX, RJ45.		Auto ▼	Disable ▼	Auto ▼

Apply

Enable

Setting	Description	Factory Default
Checked	Allows data transmission through the port	Checked
Unchecked	Immediately shuts off port access	

Media Type

Setting	Description	Factory Default
Media type	Displays the media type for each module's port	N/A

Description

Setting	Description	Factory Default
Max. 63 characters	Specifies an alias for the port to help administrators differentiate between different ports. Example: PLC 1	None

Speed

Setting	Description	Factory Default
Auto	Allows the port to use the IEEE 802.3u protocol to negotiate with connected devices. The port and connected devices will determine the best speed for that connection.	Auto
100M-Full	Choose one of these fixed speed options if the connected Ethernet device has trouble auto-negotiating for line speed.	
100M-Half		
10M-Full		
10M-Half		

FDX Flow Ctrl

This setting enables or disables flow control for the port when the port's Speed is set to Auto. The final result will be determined by the Auto process between the Moxa switch and connected devices.

Setting	Description	Factory Default
Enable	Enables flow control for this port when the port's Speed is set to Auto.	Disabled
Disable	Disables flow control for this port when the port's Speed is set to Auto.	

MDI/MDIX

Setting	Description	Factory Default
Auto	Allows the port to auto-detect the port type of the connected Ethernet device and change the port type accordingly.	Auto
MDI	Choose MDI or MDIX if the connected Ethernet device has trouble auto-negotiating for port type.	
MDIX		

RSTP Settings

The Moxa smart switch supports the standard Rapid Spanning Tree Protocol (RSTP) redundancy mechanism to increase network and system reliability. Click the RSTP (IEEE 802.1D 2004) section Edit button in the Switch Panel's and Profile section to open the settings page to further configure the RSTP protocol. You will also be able to see an overview of the RSTP status in the first part of the page.

NOTE	RSTP can be enabled by port. For more information about the RSTP concept, see Appendix A.
-------------	---

Bridge priority

Setting	Description	Factory Default
Numerical value selected by user	Increase this device's bridge priority by selecting a lower number. A device with a higher bridge priority has a greater chance of being established as the root of the Spanning Tree topology.	32768

Hello time (sec.)

Setting	Description	Factory Default
Numerical value input by user	The root of the Spanning Tree topology periodically sends out a "hello" message to other devices on the network to check if the topology is healthy. The "hello time" is the amount of time the root waits between sending hello messages.	2

Max. Age (sec.)

Setting	Description	Factory Default
Numerical value input by user	If this device is not the root, and it has not received a hello message from the root in an amount of time equal to "Max. Age," then this device will reconfigure itself as a root. Once two or more devices on the network are recognized as a root, the devices will renegotiate a new Spanning Tree topology.	20

Enable STP per Port

Setting	Description	Factory Default
Enable/Disable	Select to enable the port as a node on the Spanning Tree topology.	Disabled

NOTE We suggest not enabling the Spanning Tree Protocol once the port is connected to a device (PLC, RTU, etc.) as opposed to network equipment. The reason is that it will cause unnecessary negotiation.

Edge

Setting	Description	Factory Default
Auto	<ol style="list-style-type: none"> If the port does not receive a BPDU within 3 seconds, the port will be in the forwarding state. Once the port receives a BPDU, it will start the RSTP negotiation process. 	Auto
Force Edge	The port is fixed as an edge port and will always be in the forwarding state	
False	The port is set as the normal RSTP port	

Priority

Setting	Description	Factory Default
Numerical value selected by user	Increase this port's priority as a node on the Spanning Tree topology by entering a lower number.	128

Cost

Setting	Description	Factory Default
Numerical value input by user	Input a higher cost to indicate that this port is less suitable as a node for the Spanning Tree topology.	200000

VLAN Settings

Click the VLAN section Edit button to open the VLAN Settings page. VLANs are used to increase the efficiency of your network by dividing the LAN into logical segments, as opposed to physical segments.

NOTE See Appendix B for more information about the Virtual LAN (VLAN) Concept.

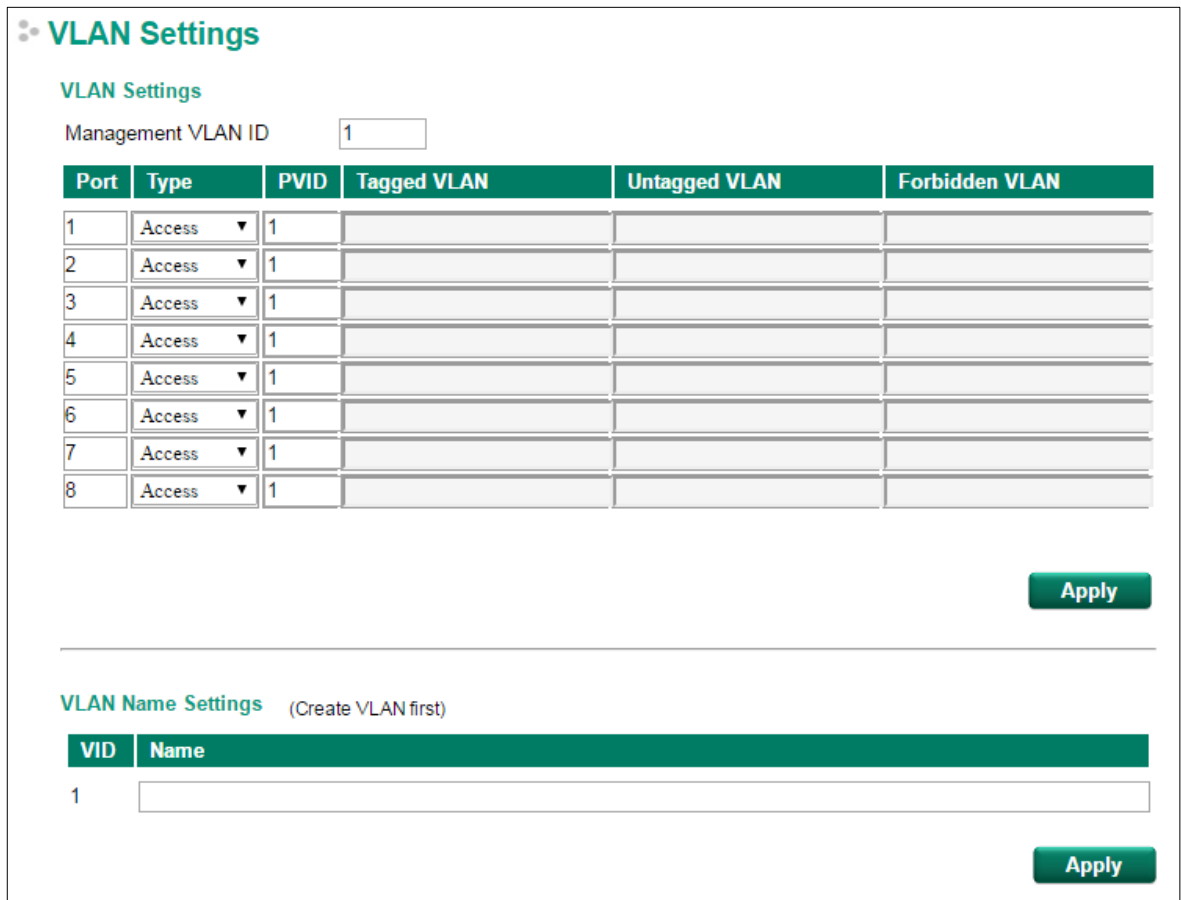
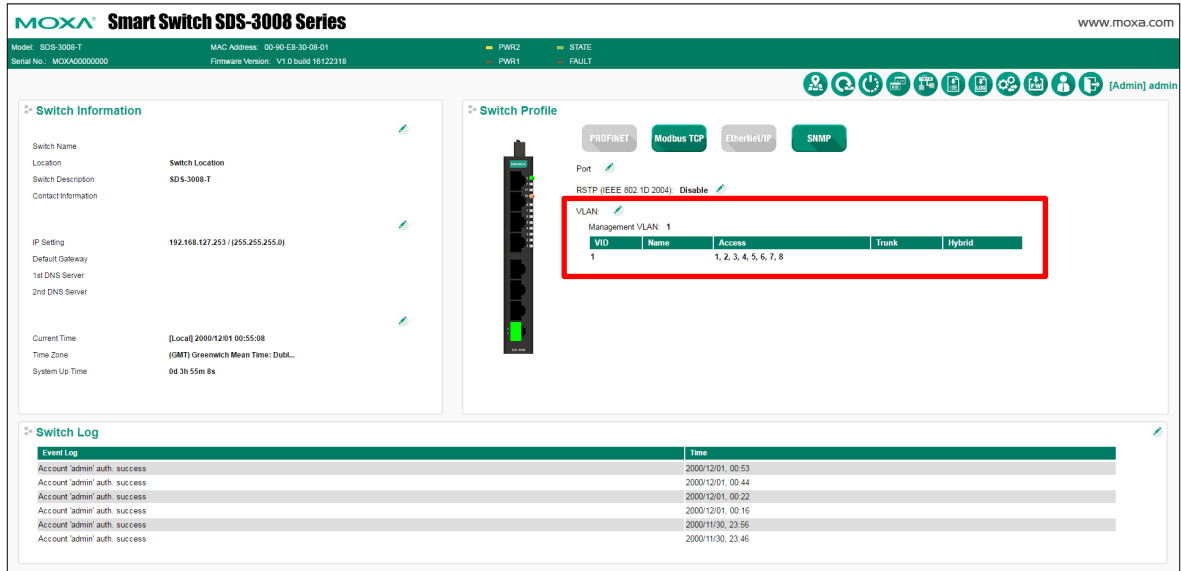

Management VLAN ID

Setting	Description	Factory Default
1 to 4094	Assigns the VLAN ID to this Moxa smart switch	1

NOTE If the smart switch is configured for other VLAN settings, to access the switch itself the PC host must be connected to the same VLAN as the management VLAN of the smart switch.

Port

Setting	Description	Factory Default
Port number	Ready only	N/A

Type

Setting	Description	Factory Default
Access	When this port is connected to a single device, without tags	Access
Trunk	When this port is connected to another 802.1Q VLAN aware switch	
Hybrid	When this port is connected to another Access 802.1Q VLAN aware switch or another LAN that combines tagged and/or untagged devices and/or other switches/hubs	

PVID

Setting	Description	Factory Default
1 to 4094	Sets the default VLAN ID for untagged devices connected to the port	1

Tagged VLAN

Setting	Description	Factory Default
1 to 4094	This field will only be active when the Trunk or Hybrid port type is selected. Set the other VLAN ID for tagged devices that connect to the port. Use commas to separate different VIDs.	None

Untagged VLAN

Setting	Description	Factory Default
1 to 4094	This field is only active when the Hybrid port type is selected. Set the other VLAN ID for tagged devices that connect to the port and tags that need to be removed in egress packets. Use commas to separate different VIDs	None

Forbidden VLAN

Setting	Description	Factory Default
1 to 4094	This field is only active when the Trunk or Hybrid port type is selected. Set the other VLAN IDs that will not be supported by this port. Use commas to separate different VIDs	None

VLAN Name Settings

You may associate a VLAN name with each VLAN ID (VID).

VLAN Name Settings

Setting	Description	Factory Default
Name	The VLAN name can only include these characters: a-z/A-Z/0-9/-/_/	None

NOTE Create the VLAN first, and then assign the VLAN name.

Switch Log

The **Switch Log** at the bottom of the switch’s configuration information dashboard shows the latest event log that was recorded. Click the Warning Edit button to check other event logs that have already been recorded, or to set event warning notifications.

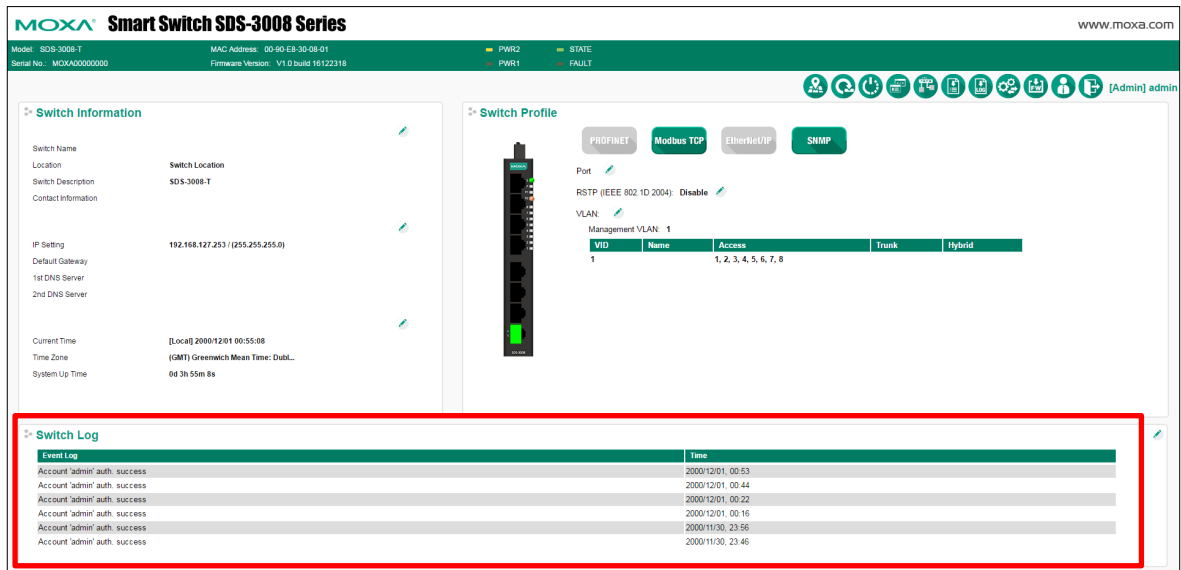

Switch Log Table

The smart switch can save up to 1000 event log entries. When the 1000-entry storage limit is reached, the switch will overwrite and delete the oldest saved event log. An example of the Switch Log Table is shown below.

Switch Log Table

Page 17/17

Index	Bootup Number	Date	Time	System Startup Time	Event
241	29	2000/11/30	00:01:12	0d 0h 1m 12s	Account 'admin' auth. success
242	29	2000/11/30	00:03:32	0d 0h 3m 32s	Account 'admin' info is changed
243	29	2000/11/30	00:03:32	0d 0h 3m 32s	Configuration change activated
244	29	2000/11/30	00:03:53	0d 0h 3m 53s	Account 'test' info is changed
245	29	2000/11/30	00:03:54	0d 0h 3m 54s	Configuration change activated
246	29	2000/11/30	00:05:17	0d 0h 5m 17s	Account 'test' info is changed
247	29	2000/11/30	00:05:18	0d 0h 5m 18s	Configuration change activated
248	29	2000/11/30	00:05:48	0d 0h 5m 48s	Account 'admin' info is changed
249	29	2000/11/30	00:05:49	0d 0h 5m 49s	Configuration change activated
250	29	2000/11/30	00:37:42	0d 0h 37m 42s	Account 'admin' auth. success
251	29	2000/11/30	00:45:39	0d 0h 45m 39s	Account 'admin' auth. success
252	29	2000/11/30	00:51:14	0d 0h 51m 14s	Account 'admin' auth. success
253	29	2000/11/30	00:56:36	0d 0h 56m 36s	Account 'admin' auth. success

Clear Refresh

The Switch Log Table displays the following information for each event:

Index	An event index assigned to identify the event sequence.
Bootup Number	This field shows how many times the Moxa switch has been rebooted or cold started.
Date	The date is updated based on how the current date is set on the System Settings page.
Time	The time is updated based on how the current time is set on the System Settings page.
System Startup Time	The system startup time related to this event.
Event	Events that have occurred.

Warning Notification Settings

Since industrial Ethernet devices are often located at the endpoints of a system, these devices will not always know what is happening elsewhere on the network. To get around this problem, the industrial Ethernet switches that connect to these devices should be able to send real-time alarm messages to system maintainers. Even when control engineers are out of the control room for an extended period of time, they can still be informed of the status of devices almost instantaneously when exceptions occur. Moxa’s smart switches support SNMP trap, syslog, and relay output, and each switch has one digital input for integrating sensors. Click the Switch Log Edit button to view the Switch Log Settings page.

Switch Log Settings

Warning Notification Settings

Warning Notification: Enable warning notification will trigger syslog and snmp trap

Syslog Server 1: IP: UDP Port: (1~65535)

Syslog Server 2: IP: UDP Port: (1~65535)

Relay: PWR1 (ON->OFF) DI 1 (ON)

PWR2 (ON->OFF) DI 1 (OFF)

The STP/RSTP Concept

Spanning Tree Protocol (STP) was designed to help reduce link failures on a network, and provide an automatic means of avoiding loops. This is particularly important for networks that have a complicated architecture, since unintended loops in the network can cause broadcast storms. By default, STP is disabled on all Moxa switches. To work properly, RSTP/STP must be enabled on every Moxa switch connected to your network.

Rapid Spanning Tree Protocol (RSTP) implements the Spanning Tree Algorithm and Protocol defined by IEEE 802.1D-2004. RSTP provides the following benefits:

- The topology of a bridged network will be determined much more quickly compared to STP.
- RSTP is backwards compatible with STP, making it relatively easy to deploy. For example:
 - Defaults to sending 802.1D style BPDUs if packets with this format are received.
 - STP (802.1D) and RSTP (802.1w) can operate on different ports of the same switch, which is particularly helpful when switch ports connect to older equipment such as legacy switches.

You get essentially the same functionality with RSTP and STP. To see how the two systems differ, see the **Differences between STP and RSTP** section later in this chapter.

NOTE The STP protocol is part of the IEEE Std 802.1D, 2004 Edition bridge specification. The following explanation uses "bridge" instead of "switch."

What is STP?

STP (802.1D) is a bridge-based system that is used to implement parallel paths for network traffic. STP uses a loop-detection process to:

- Locate and then disable less efficient paths (i.e., paths that have a lower bandwidth).
- Enable one of the less efficient paths if a more efficient path fails.

The figure below shows a network made up of three LANs separated by three bridges. Each segment uses at most two paths to communicate with the other segments. Since this configuration can give rise to loops, the network will overload if STP is NOT enabled.

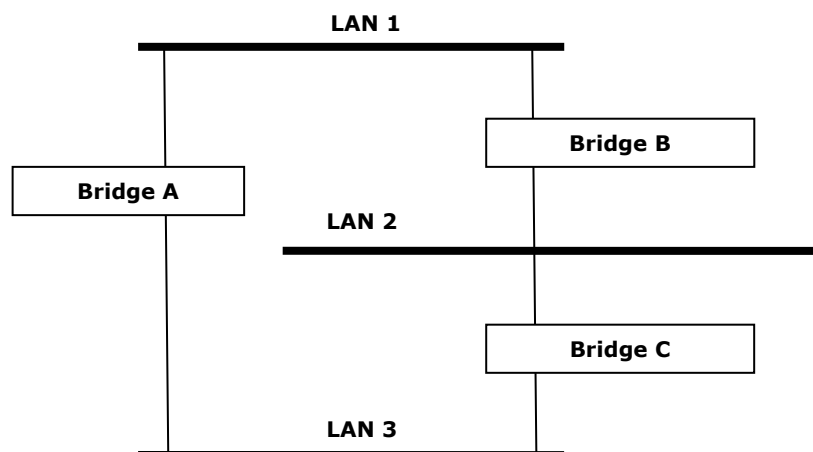

If STP is enabled, it will detect duplicate paths and prevent, or *block*, one of the paths from forwarding traffic. In the following example, STP determined that traffic from LAN segment 2 to LAN segment 1 should flow through bridges C and A since this path has a greater bandwidth and is therefore more efficient.

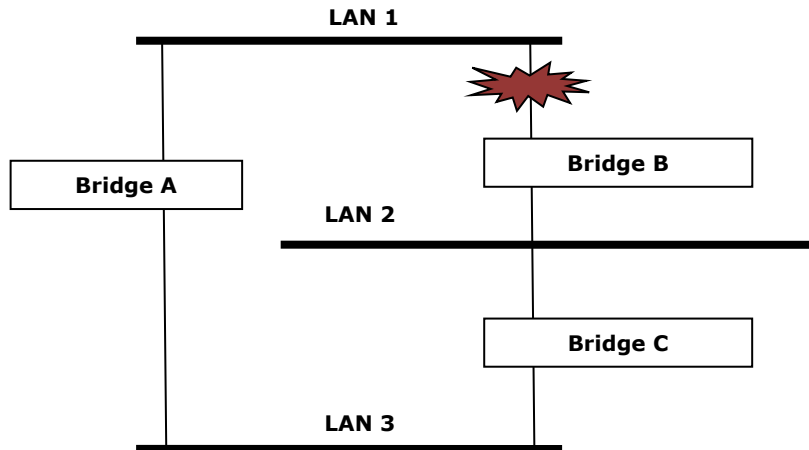

What happens if a link failure is detected? As shown in the next figure, the STP process reconfigures the network so that traffic from LAN segment 2 flows through bridge B.

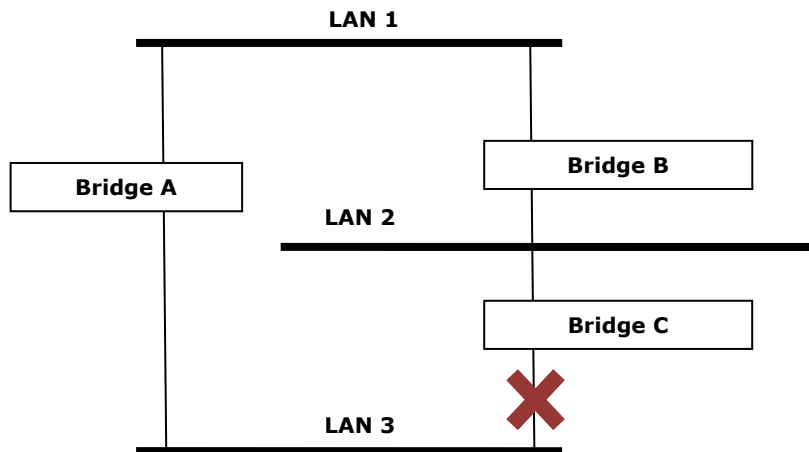

STP will examine each bridged segment determine which path is most efficient, and then assign a specific reference point on the network. When the most efficient path has been identified, the other paths are blocked. In the previous 3 figures, STP first determined that the path through bridge C was the most efficient, and as a result, blocked the path through bridge B. After the failure of bridge C, STP re-evaluated the situation and opened the path through Bridge B.

How STP Works

When enabled, STP determines the most appropriate path for traffic through a network. The way it does this is outlined in the sections below.

STP Requirements

Before STP can configure the network, the system must satisfy the following requirements:

- All bridges must be able to communicate with each other. The communication is carried out using Bridge Protocol Data Units (BPDUs), which are transmitted in packets with a known multicast address.
- Each bridge must have a Bridge Identifier that specifies which bridge acts as the central reference point, or Root Bridge, for the STP system—bridges with a lower Bridge Identifier are more likely to be designated as the Root Bridge. The Bridge Identifier is calculated using the MAC address of the bridge and a priority defined for the bridge. For example, the default priority setting of Moxa switches is 32768.

- Each port has a cost that specifies the efficiency of each link. The efficiency cost is usually determined by the bandwidth of the link, with less efficient links assigned a higher cost.

STP Calculation

The first step of the STP process is to perform calculations. During this stage, each bridge on the network transmits BPDUs. The following items will be calculated:

- Which bridge should be the **Root Bridge**. The Root Bridge is the central reference point from which the network is configured.
- The **Root Path Costs** for each bridge. This is the cost of the paths from each bridge to the Root Bridge.
- The identity of each bridge's **Root Port**. The Root Port is the port on the bridge that connects to the Root Bridge via the most efficient path. In other words, the port connected to the Root Bridge via the path with the lowest Root Path Cost. The Root Bridge, however, does not have a Root Port.
- The identity of the **Designated Bridge** for each LAN segment. The Designated Bridge is the bridge with the lowest Root Path Cost from that segment. If several bridges have the same Root Path Cost, the one with the lowest Bridge Identifier becomes the Designated Bridge. Traffic transmitted in the direction of the Root Bridge will flow through the Designated Bridge. The port on this bridge that connects to the segment is called the **Designated Bridge Port**.

STP Configuration

After all of the bridges on the network agree on the identity of the Root Bridge, and all other relevant parameters have been established, each bridge is configured to forward traffic only between its Root Port and the Designated Bridge Ports for the respective network segments. All other ports are blocked, which means that they will not be allowed to receive or forward traffic.

STP Reconfiguration

Once the network topology has stabilized, each bridge listens for Hello BPDUs transmitted from the Root Bridge at regular intervals. If a bridge does not receive a Hello BPDU after a certain interval (the Max Age time), the bridge assumes that the Root Bridge, or a link between itself and the Root Bridge, has ceased to function. This will trigger the bridge to reconfigure the network to account for the change. If you have configured an SNMP trap destination, the first bridge to detect the change will send out an SNMP trap when the topology of your network changes.

Differences between STP and RSTP

RSTP is similar to STP, but includes additional information in the BPDUs that allow each bridge to confirm that it has taken action to prevent loops from forming when it decides to enable a link to a neighboring bridge. Adjacent bridges connected via point-to-point links will be able to enable a link without waiting to ensure that all other bridges in the network have had time to react to the change. The main benefit of RSTP is that the configuration decision is made locally rather than network-wide, allowing RSTP to carry out automatic configuration and restore a link faster than STP.

The Virtual LAN (VLAN) Concept

What is a VLAN?

A VLAN is a group of devices that can be located anywhere on a network, but which communicate as if they are on the same physical segment. With VLANs, you can segment your network without being restricted by physical connections—a limitation of traditional network design. With VLANs you can segment your network into:

- **Departmental groups**—You could have one VLAN for the marketing department, another for the finance department, and another for the product development department.
- **Hierarchical groups**—You could have one VLAN for directors, another for managers, and another for general staff.
- **Usage groups**—You could have one VLAN for email users and another for multimedia users.

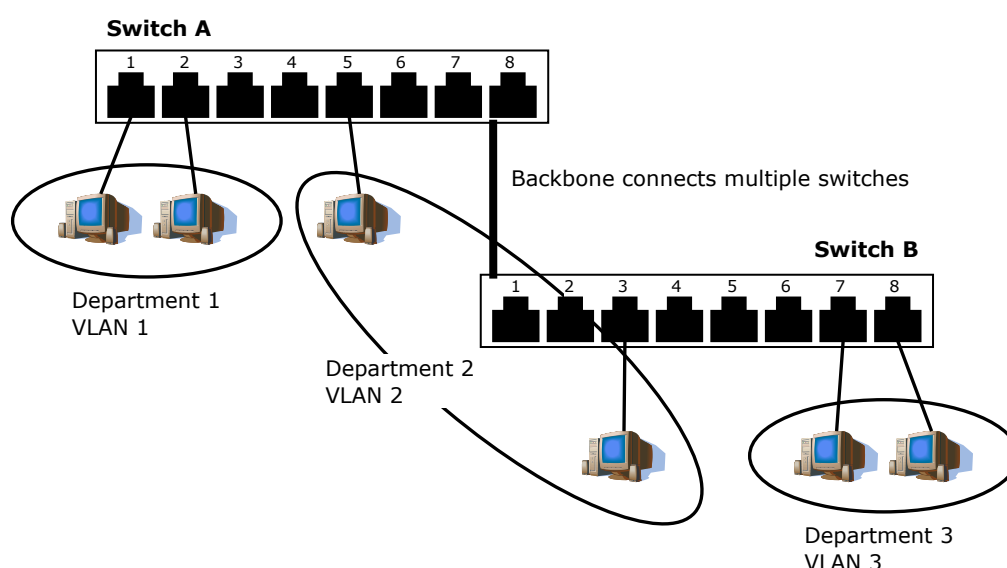

Benefits of VLANs

The main benefit of VLANs is that they provide a network segmentation system that is far more flexible than traditional networks. Using VLANs also provides you with three other benefits:

- **VLANs make it easier to relocate devices on networks:** With traditional networks, network administrators spend much of their time dealing with moves and changes. If users move to a different subnetwork, the addresses of each host must be updated manually. With a VLAN setup, if a host originally on the Marketing VLAN is moved to a port on another part of the network, and retains its original subnet membership, you only need to specify that the new port is on the Marketing VLAN. You do not need to do any re-cabling.
- **VLANs provide extra security:** Devices within each VLAN can only communicate with other devices on the same VLAN. If a device on the Marketing VLAN needs to communicate with devices on the Finance VLAN, the traffic must pass through a routing device or Layer 3 switch.

- **VLANs help control traffic:** With traditional networks, congestion can be caused by broadcast traffic that is directed to all network devices, regardless of whether or not they need it. VLANs increase the efficiency of your network because each VLAN can be set up to contain only those devices that need to communicate with each other.

VLANs and the Rackmount switch

Your Moxa switch provides support for VLANs using IEEE Std 802.1Q-1998. This standard allows traffic from multiple VLANs to be carried across one physical link. The IEEE Std 802.1Q-1998 standard allows each port on your Moxa switch to be placed as follows:

- On a single VLAN defined in the Moxa switch
- On several VLANs simultaneously using 802.1Q tagging

The standard requires that you define the *802.1Q VLAN ID* for each VLAN on your Moxa switch before the switch can use it to forward traffic.

Managing a VLAN

A new or initialized Moxa switch contains a single VLAN—the Default VLAN. This VLAN has the following definition:

- *VLAN Name*—Management VLAN
- *802.1Q VLAN ID*—1 (if tagging is required)

All the ports are initially placed on this VLAN, and it is the only VLAN that allows you to access the management software of the Moxa switch over the network.

Communication between VLANs

If devices connected to a VLAN need to communicate with devices on a different VLAN, a router or Layer 3 switching device with connections to both VLANs needs to be installed. Communication between VLANs can only take place if they are all connected to a routing or Layer 3 switching device.

VLANs: Tagged and Untagged Membership

The Moxa switch supports 802.1Q VLAN tagging, a system that allows traffic for multiple VLANs to be carried on a single physical link (backbone, trunk). When setting up VLANs you need to understand when to use untagged or tagged membership of VLANs. Simply put, if a port is on a single VLAN it can be an untagged member, but if the port needs to be a member of multiple VLANs, a tagged membership must be defined.

A typical host (e.g., clients) will be an untagged member of one VLAN, defined as an **Access Port** in a Moxa switch, while an inter-switch connection will be a tagged member of all VLANs, defined as a **Trunk Port** on a Moxa switch.

The IEEE Std 802.1Q-1998 defines how VLANs operate within an open packet-switched network. An 802.1Q compliant packet carries additional information that allows a switch to determine which VLAN the port belongs to. If a frame is carrying the additional information, it is known as a *tagged* frame.

To carry multiple VLANs across a single physical link (backbone, trunk), each packet must be tagged with a VLAN identifier so that the switches can identify which packets belong in which VLAN. To communicate between VLANs, a router must be used.

The Moxa switch supports three types of VLAN port settings:

- **Access Port:** The port connects to a single device that is not tagged. The user must define the default port PVID that assigns which VLAN the device belongs to. Once the ingress packet of this Access Port egresses

to another Trunk Port (the port needs all packets to carry tag information), the Moxa switch will insert this PVID into this packet so the next 802.1Q VLAN switch can recognize it.

- **Trunk Port:** The port connects to a LAN that consists of untagged devices, tagged devices, and/or switches and hubs. In general, the traffic of the Trunk Port must have a Tag. Users can also assign a PVID to a Trunk Port. The untagged packet on the Trunk Port will be assigned the default port PVID as its VID.
- **Hybrid Port:** The port is similar to a Trunk port, except users can explicitly assign tags to be removed from egress packets.

The following section illustrates how to use these ports to set up different applications.

Sample Applications of VLANs Using Moxa Switches

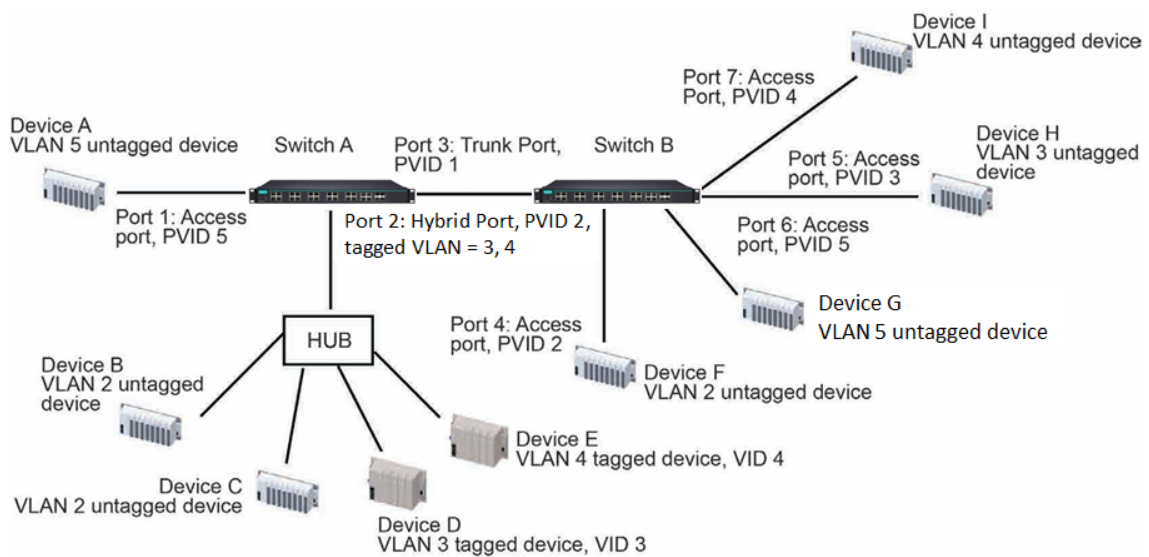

In this application:

- Port 1 connects a single untagged device and assigns it to VLAN 5; it should be configured as an **Access Port** with PVID 5.
- Port 2 connects a LAN with two untagged devices belonging to VLAN 2. One tagged device with VID 3 and one tagged device with VID 4. It should be configured as a **Hybrid Port** with PVID 2 for untagged device and Fixed VLAN (Tagged) with 3 and 4 for tagged device. Since each port can only have one unique PVID, all untagged devices on the same port must belong to the same VLAN.
- Port 3 connects with another switch. It should be configured as a **Trunk Port**. GVRP protocol will be used through the Trunk Port.
- Port 4 connects a single untagged device and assigns it to VLAN 2; it should be configured as an **Access Port** with PVID 2.
- Port 5 connects a single untagged device and assigns it to VLAN 3; it should be configured as an **Access Port** with PVID 3.
- Port 6 connects a single untagged device and assigns it to VLAN 5; it should be configured as an **Access Port** with PVID 5.
- Port 7 connects a single untagged device and assigns it to VLAN 4; it should be configured as an **Access Port** with PVID 4.

After the application is properly configured:

- Packets from Device A will travel through **Trunk Port 3** with tagged VID 5. Switch B will recognize its VLAN, pass it to port 6, and then remove tags received successfully by Device G, and vice versa.
- Packets from Devices B and C will travel through **Hybrid Port 2** with tagged VID 2. Switch B recognizes its VLAN, passes it to port 4, and then removes tags received successfully by Device F, and vice versa.

- Packets from Device D will travel through **Trunk Port 3** with tagged VID 3. Switch B will recognize its VLAN, pass to port 5, and then remove tags received successfully by Device H. Packets from Device H will travel through **Trunk Port 3** with PVID 3. Switch A will recognize its VLAN and pass it to port 2, but will not remove tags received successfully by Device D.
- Packets from Device E will travel through **Trunk Port 3** with tagged VID 4. Switch B will recognize its VLAN, pass it to port 7, and then remove tags received successfully by Device I. Packets from Device I will travel through **Trunk Port 3** with tagged VID 4. Switch A will recognize its VLAN and pass it to port 2, but will not remove tags received successfully by Device E.